



























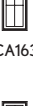







CASEMENT

Operating Units – 18", 24", 30", 36" Widths

Masonry Opening	1' - 6" (457)	2' - 0" (610)	2' - 6" (762)	3' - 0" (914)
Rough Opening	1' - 6" (457)	2' - 0" (610)	2' - 6" (762)	3' - 0" (914)
Frame Size	1' - 5 1/2" (445)	1' - 11 1/2" (597)	2' - 5 1/2" (749)	2' - 11 1/2" (902)
Glass Size	12 15/16" (329)	18 15/16" (481)	24 15/16" (633)	29 15/16" (760)

5' - 11 3/4" (1822)				
5' - 11 1/2" (1816)				
5' - 11 1/2" (1816)				
5' - 11 1/2" (1816)				
5' - 11 1/2" (1816)				
5' - 11 1/2" (1816)				
5' - 11 1/2" (1816)				
5' - 11 1/2" (1816)				
5' - 11 1/2" (1816)				

GBG available in standard Rectangular lite cut shown.

* These windows meet National Egress Codes for fire evacuation. Local codes may differ.

† These units include a sash limiting device, which can be released from the inside without the use of a key, tool, special knowledge, or force greater than that required for normal unit operation. The sash limiting device is not a "window opening control device" as per ASTM F 2090-08 and referenced under IRC-2006 Section R613.2 or IBC-2006 Section 1405.12.2. It is not designed to prevent child falls.

Details and Elevations not to scale.

Obscure Glass option available on all units.

T = Standard Tempered

Special sized units available within product size matrix. See your Integrity® retailer.

MULTIPLE ASSEMBLIES

Multiple assemblies can be factory mullied up to 4 units wide by 1 unit high.

MAXIMUM ROUGH OPENING:
not to exceed 114" x 78" or up to 2 units wide by 2 units high.

MAXIMUM ROUGH OPENING:
not to exceed 96" x 96". Field mull kits are available. Structural mullion reinforcement is required for some assemblies.













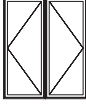
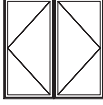



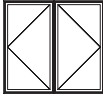







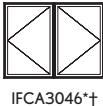



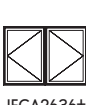

Please consult your local Integrity from Marvin representative for more information.

CASEMENT

INTEGRITY® FROM MARVIN
ALL ULTREX® SERIES

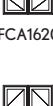
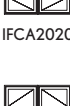
2 Wide Operating Units – 18", 24", 30", 36" Widths

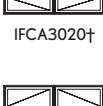

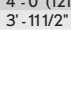
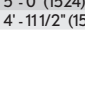
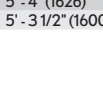









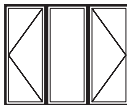
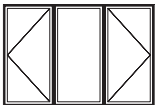

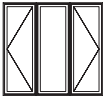
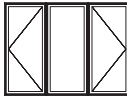
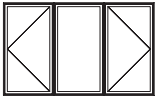





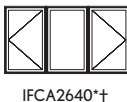
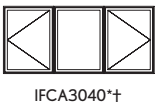

Masonry Opening	3' - 0" (914)	4' - 0" (1219)	5' - 0" (1524)	5' - 4" (1626)
Rough Opening	3' - 0" (914)	4' - 0" (1219)	5' - 0" (1524)	5' - 4" (1626)
Frame Size	2' - 11 1/2" (902)	3' - 11 1/2" (1207)	4' - 11 1/2" (1511)	5' - 3 1/2" (1600)

5' - 11 3/4" (1822) 6' - 0" (1829) 5' - 11 1/2" (1816)				
5' - 5 3/4" (1670) 5' - 6" (1676) 5' - 5 1/2" (1664)				
4' - 11 3/4" (1518) 5' - 0" (1524) 4' - 11 1/2" (1511)				
4' - 5 3/4" (1365) 4' - 6" (1372) 4' - 5 1/2" (1359)				
3' - 11 3/4" (1213) 4' - 0" (1219) 3' - 11 1/2" (1207)				
3' - 5 3/4" (1060) 3' - 6" (1067) 3' - 5 1/2" (1054)				
2' - 11 3/4" (908) 3' - 0" (914) 2' - 11 1/2" (902)				
2' - 5 3/4" (756) 2' - 6" (762) 2' - 5 1/2" (749)				
2' - 11 3/4" (603) 2' - 0" (610) 1' - 11 1/2" (597)				

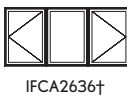
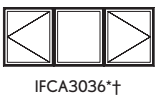
CASEMENT

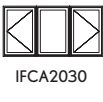
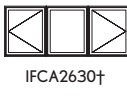
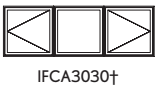
3 Wide Operating Units – 18", 24", 30", 36" Widths

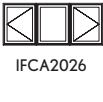
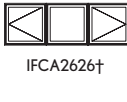
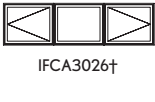
Masonry Opening	4' - 6" (1372)	6' - 0" (1829)	7' - 6" (2286)	9' - 0" (2743)
Rough Opening	4' - 6" (1372)	6' - 0" (1829)	7' - 6" (2286)	9' - 0" (2743)
Frame Size	4' - 5 1/2" (1359)	5' - 11 1/2" (1816)	7' - 5 1/2" (2273)	8' - 11 1/2" (2731)

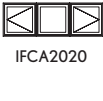
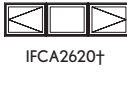
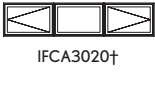
5' - 11 3/4" (1822) 6' - 0" (1829) 5' - 11 1/2" (1816)	 IFCA1660T	 IFCA2060T	 IFCA2660T*†	 IFCA3060T*†
5' - 5 3/4" (1670) 5' - 6" (1676) 5' - 5 1/2" (1664)	 IFCA1656	 IFCA2056	 IFCA2656*†	 IFCA3056*†
4' - 11 3/4" (1518) 5' - 0" (1524) 4' - 11 1/2" (1511)	 IFCA1650	 IFCA2050	 IFCA2650*†	 IFCA3050*†
4' - 5 3/4" (1365) 4' - 6" (1372) 4' - 5 1/2" (1359)	 IFCA1646	 IFCA2046	 IFCA2646*†	 IFCA3046*†
3' - 11 3/4" (1213) 4' - 0" (1219) 3' - 11 1/2" (1207)	 IFCA1640	 IFCA2040	 IFCA2640*†	 IFCA3040*†
3' - 5 3/4" (1060) 3' - 6" (1067) 3' - 5 1/2" (1054)	 IFCA1636	 IFCA2036	 IFCA2636*†	 IFCA3036*†
2' - 11 3/4" (908) 3' - 0" (914) 2' - 11 1/2" (902)	 IFCA1630	 IFCA2030	 IFCA2630*†	 IFCA3030*†
2' - 5 3/4" (756) 2' - 6" (762) 2' - 5 1/2" (749)	 IFCA1626	 IFCA2026	 IFCA2626*†	 IFCA3026*†
1' - 11 3/4" (603) 2' - 0" (610) 1' - 11 1/2" (597)	 IFCA1620	 IFCA2020	 IFCA2620*†	 IFCA3020*†

GBG available in standard Rectangular lite cut shown.

* These windows meet National Egress Codes for fire evacuation. Local codes may differ.

† These units include a sash limiting device, which can be released from the inside without the use of a key, tool, special knowledge, or force greater than that required for normal unit operation. The sash limiting device is not a "window opening control device" as per ASTM F 2090-08 and referenced under IRC-2006 Section R613.2 or IBC-2006 Section 1405.12.2. It is not designed to prevent child falls.

Details and Elevations not to scale.

Obscure Glass option available on all units.

T = Standard Tempered

Special sized units available within product size matrix. See your Integrity® retailer.

MULTIPLE ASSEMBLIES

Multiple assemblies can be factory mullered up to 4 units wide by 1 unit high.

MAXIMUM ROUGH OPENING:
not to exceed 114" x 78" or up to 2 units wide by 2 units high.

MAXIMUM ROUGH OPENING:
not to exceed 96" x 96". Field mull kits are available. Structural mullion reinforcement is required for some assemblies.







Please consult your local Integrity from Marvin representative for more information.

CASEMENT

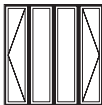
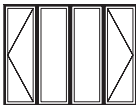
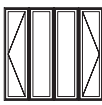
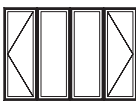
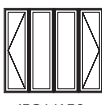
INTEGRITY® FROM MARVIN
ALL ULTREX® SERIES

4 Wide Operating Units – 18", 24" Widths

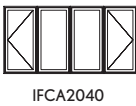
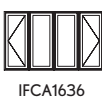
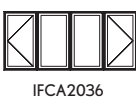
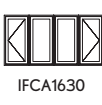
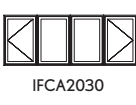
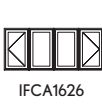
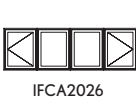
Masonry Opening	6' - 0" (1829)	8' - 0" (2438)
Rough Opening	6' - 0" (1829)	8' - 0" (2438)
Frame Size	5' - 11 1/2" (1816)	7' - 11 1/2" (2426)

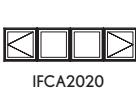
5' - 11 3/4" (1822)		
6' - 0" (1829)		
5' - 11 1/2" (1816)		
5' - 5 3/4" (1670)		
5' - 6" (1676)		
5' - 5 1/2" (1664)		
4' - 11 3/4" (1518)		
5' - 0" (1524)		
4' - 11 1/2" (1511)		
4' - 5 3/4" (1365)		
4' - 6" (1372)		
4' - 5 1/2" (1359)		
3' - 11 3/4" (1213)		
4' - 0" (1219)		
3' - 11 1/2" (1207)		
3' - 5 3/4" (1060)		
3' - 6" (1067)		
3' - 5 1/2" (1054)		
2' - 11 3/4" (908)		
3' - 0" (914)		
2' - 11 1/2" (902)		
2' - 5 3/4" (756)		
2' - 6" (762)		
2' - 5 1/2" (749)		
1' - 11 3/4" (603)		
2' - 0" (610)		
1' - 11 1/2" (597)		

CASEMENT Transoms and Multiple Assemblies

96" Casement Flankers with Swinging Picture Unit

Masonry Opening	2' - 0" (610)	4' - 0" (1219)	2' - 0" (610)
Rough Opening	2' - 0" (610)	4' - 0" (1219)	2' - 0" (610)
Frame Size	1' - 11 1/2" (597)	3' - 11 1/2" (1207)	1' - 11 1/2" (597)
Glass Size	18 15/16" (481)	43 17/32" (1106)	18 15/16" (481)

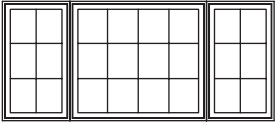
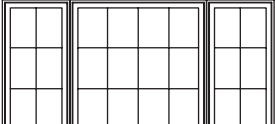
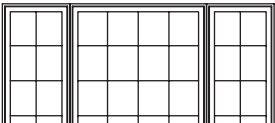
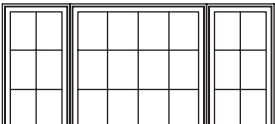
<p>3' - 5 3/4" (1060) 3' - 6" (1067) 3' - 5 1/2" (1054) 18 9/32" (464)</p>	 <p>IFCA2036 IFSWP4036 IFCA2036</p>
<p>3' - 11 3/4" (1213) 4' - 0" (1219) 3' - 11 1/2" (1207) 21 9/32" (541)</p>	 <p>IFCA2040 IFSWP4040 IFCA2040</p>
<p>4' - 5 3/4" (1365) 4' - 6" (1372) 4' - 5 1/2" (1359) 24 9/32" (617)</p>	 <p>IFCA2046 IFSWP4046 IFCA2046</p>
<p>4' - 11 3/4" (1518) 5' - 0" (1524) 4' - 11 1/2" (1511) 27 9/32" (693)</p>	 <p>IFCA2050 IFSWP4050 IFCA2050</p>

108" Casement Flankers with Swinging Picture Unit

Masonry Opening	2' - 0" (610)	5' - 0" (1524)	2' - 0" (610)
Rough Opening	2' - 0" (610)	5' - 0" (1524)	2' - 0" (610)
Frame Size	1' - 11 1/2" (597)	4' - 11 1/2" (1511)	1' - 11 1/2" (597)
Glass Size	18 15/16" (481)	55 17/32" (1411)	18 15/16" (481)

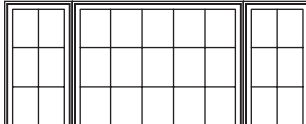
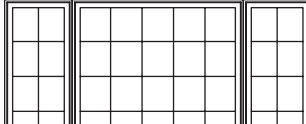
<p>4' - 11 3/4" (1518) 5' - 0" (1524) 4' - 11 1/2" (1511) 27 9/32" (693)</p>	 <p>IFCA2050 IFSWP5050 IFCA2050</p>
<p>5' - 5 3/4" (1670) 5' - 6" (1676) 5' - 5 1/2" (1664) 30 9/32" (769)</p>	 <p>IFCA2056 IFSWP5056 IFCA2056</p>

Construction Details

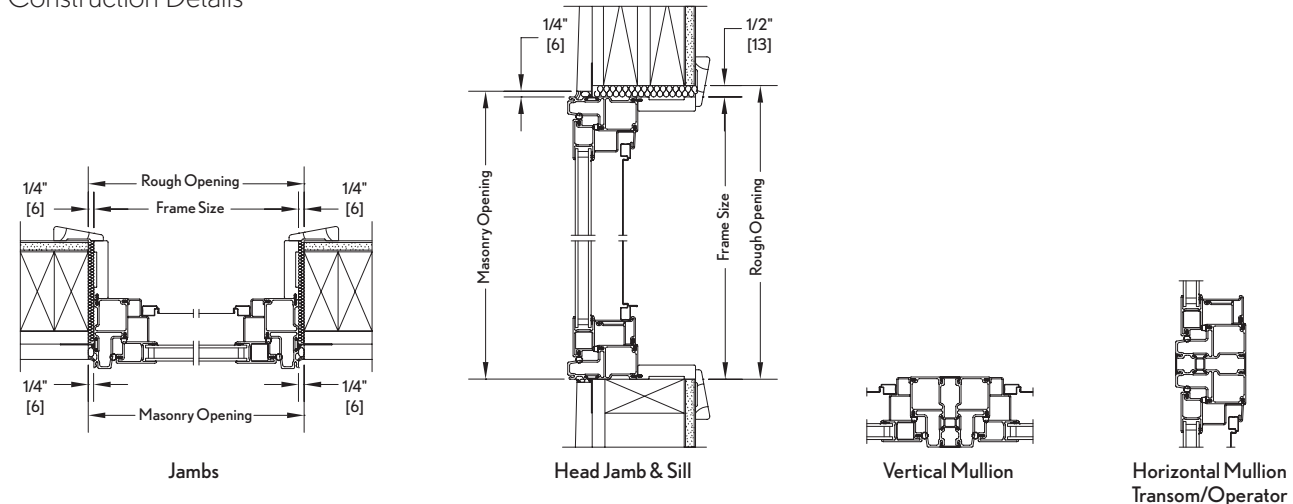

Operating Units – 16", 20", 26", 30", 36", 40" Widths

Masonry Opening	1' - 6" (457)	2' - 0" (610)	2' - 6" (762)	3' - 0" (914)	3' - 6" (1067)	4' - 0" (1219)
Rough Opening	1' - 6" (457)	2' - 0" (610)	2' - 6" (762)	3' - 0" (914)	3' - 6" (1067)	4' - 0" (1219)
Frame Size	1' - 5 1/2" (445)	1' - 11 1/2" (597)	2' - 5 1/2" (749)	2' - 11 1/2" (902)	3' - 5 1/2" (1054)	3' - 11 1/2" (1207)
Glass Size	13 17/32" (344)	19 17/32" (496)	25 17/32" (649)	31 17/32" (801)	37 17/32" (953)	43 17/32" (1106)

1' - 5 3/4" (451)	IFAWN1616	IFAWN2016	IFAWN2616	IFAWN3016	IFAWN3616	IFAWN4016
1' - 6" (457)						
1' - 11 1/2" (597)	IFAWN1620	IFAWN2020	IFAWN2620	IFAWN3020	IFAWN3620	IFAWN4020
2' - 0" (610)						
2' - 5 1/2" (749)	IFAWN1626	IFAWN2026	IFAWN2626	IFAWN3026	IFAWN3626	IFAWN4026
2' - 6" (762)						
2' - 11 1/2" (902)	IFAWN1630	IFAWN2030	IFAWN2630	IFAWN3030	IFAWN3630	IFAWN4030
15 9/32" (388)						

Construction Details

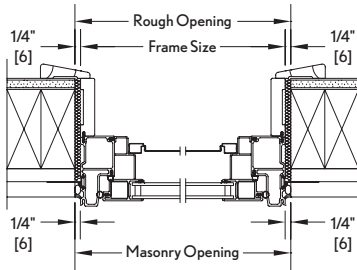

Jamb

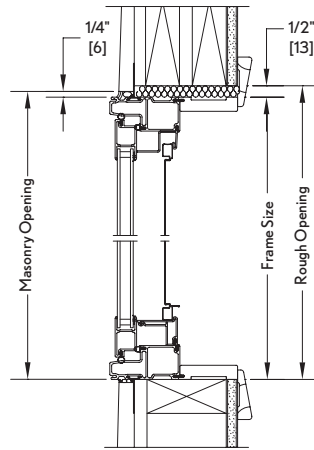

Head Jamb & Sill

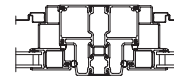

Vertical Mullion



Horizontal Mullion Transom/Operator

* These windows meet National Egress Codes for fire evacuation. Local codes may differ.

** This product is only available field mullied.

Details and Elevations not to scale.

Obscure Glass option available on all units.

Special sized units available within product size matrix. See your Integrity retailer.

MULTIPLE ASSEMBLIES

Multiple assemblies can be factory mullied up to 4 units wide by 1 unit high.

MAXIMUM ROUGH OPENING:
not to exceed 114" x 78" or up to 2 units wide by 2 units high.

























MAXIMUM ROUGH OPENING:
not to exceed 96" x 96". Field mull kits are available. Structural mullion reinforcement is required for some assemblies.

Please consult your local Integrity from Marvin representative for more information.

AWNING













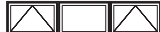

2 Wide Operating Units – 16", 20", 26", 30", 36", 40" Widths

Masonry Opening	3' - 0" (914)	4' - 0" (1219)	5' - 0" (1524)	6' - 0" (1829)	7' - 0" (2134)	8' - 0" (2438)
Rough Opening	3' - 0" (914)	4' - 0" (1219)	5' - 0" (1524)	6' - 0" (1829)	7' - 0" (2134)	8' - 0" (2438)
Frame Size	2' - 11 1/2" (902)	3' - 11 1/2" (1207)	4' - 11 1/2" (1511)	5' - 11 1/2" (1816)	6' - 11 1/2" (2121)	7' - 11 1/2" (2426)

1' - 5 3/4" (451)						
IFAWN1616	IFAWN2016	IFAWN2616	IFAWN3016	IFAWN3616	IFAWN4016	
1' - 11" 3/4" (603)						
IFAWN1620	IFAWN2020	IFAWN2620	IFAWN3020	IFAWN3620	IFAWN4020	
1' - 6" (457)						
IFAWN1626	IFAWN2026	IFAWN2626	IFAWN3026	IFAWN3626	IFAWN4026	
2' - 5 3/4" (756)						
IFAWN1630	IFAWN2030	IFAWN2630	IFAWN3030	IFAWN3630	IFAWN4030	
2' - 0" (610)						
2' - 6" (762)						
2' - 11 1/2" (902)						
2' - 11 1/2" (902)						

3 Wide Operating Units – 16", 20", 26", 30" Widths

Masonry Opening	4' - 6" (1372)	6' - 0" (1829)	7' - 6" (2286)	9' - 0" (2743)
Rough Opening	4' - 6" (1372)	6' - 0" (1829)	7' - 6" (2286)	9' - 0" (2743)
Frame Size	4' - 5 1/2" (1359)	5' - 11 1/2" (1816)	7' - 5 1/2" (2273)	8' - 11 1/2" (2731)

1' - 5 3/4" (451)				
IFAWN1616	IFAWN2016	IFAWN2616	IFAWN3016	
1' - 11" 3/4" (603)				
IFAWN1620	IFAWN2020	IFAWN2620	IFAWN3020	
1' - 6" (457)				
IFAWN1626	IFAWN2026	IFAWN2626	IFAWN3026	
2' - 5 3/4" (756)				
IFAWN1630	IFAWN2030	IFAWN2630	IFAWN3030	
2' - 0" (610)				
2' - 6" (762)				
2' - 11 1/2" (902)				
2' - 11 1/2" (902)				

* These windows meet National Egress Codes for fire evacuation. Local codes may differ.

** This product is only available field mullied.

Details and Elevations not to scale.

Obscure Glass option available on all units.

Special sized units available within product size matrix. See your Integrity® retailer.

MULTIPLE ASSEMBLIES

Multiple assemblies can be factory mullied up to 4 units wide by 1 unit high.

MAXIMUM ROUGH OPENING:
not to exceed 114" x 78" or up to 2 units wide by 2 units high.

MAXIMUM ROUGH OPENING:
not to exceed 96" x 96". Field mull kits are available. Structural mullion reinforcement is required for some assemblies.

Please consult your local Integrity from Marvin representative for more information.

AWNING

INTEGRITY® FROM MARVIN
ALL ULTREX® SERIES

4 Wide Operating Units – 16", 20" Widths

Masonry Opening	6' - 0" (1829)	8' - 0" (2438)
Rough Opening	6' - 0" (1829)	8' - 0" (2438)
Frame Size	5' - 11 1/2" (1816)	7' - 11 1/2" (2426)

2' - 11 3/4" (908)	2' - 5 3/4" (756)	1' - 11" 3/4" (603)	1' - 5 3/4" (451)
3' - 0" (914)	2' - 6" (762)	2' - 0" (610)	1' - 6" (457)
2' - 11 1/2" (902)	2' - 5 1/2" (749)	1' - 11 1/2" (597)	1' - 5 1/2" (445)



IFAWN1616



IFAWN2016



IFAWN1620



IFAWN2020



IFAWN1626



IFAWN2026



IFAWN1630







IFAWN2030

SWINGING PICTURE AND TRANSOM UNITS

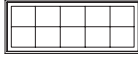
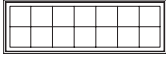
Picture Units

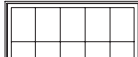
Masonry Opening	3' - 6" (1067)	4' - 0" (1219)	5' - 0" (1524)	6' - 0" (1829)
Rough Opening	3' - 6" (1067)	4' - 0" (1219)	5' - 0" (1524)	6' - 0" (1829)
Frame Size	3' - 5 1/2" (1054)	3' - 11 1/2" (1207)	4' - 11 1/2" (1511)	5' - 11 1/2" (1816)
Glass Size	37 17/32" (953)	43 17/32" (1106)	55 17/32" (1411)	

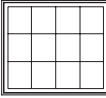
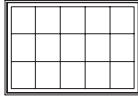
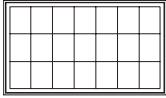
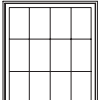
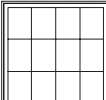
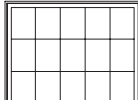
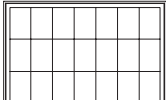
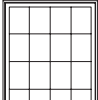
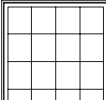
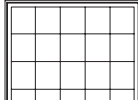
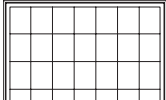
1' - 1 3/4" (603) 2' - 0" (610) 1' - 11/2" (597) 9 9/32" (236)				
			IFSHP5020	IFSHP6020
2' - 5 3/4" (756) 2' - 6" (762) 2' - 5 1/2" (749) 12 9/32" (312)				
			IFSHP5026	IFSHP6026
2' - 11 3/4" (908) 3' - 0" (914) 2' - 11 1/2" (902) 15 9/32" (388)				
			IFSHP5030	IFSHP6030
3' - 5 3/4" (1060) 3' - 6" (1067) 3' - 5 1/2" (1054) 18 9/32" (464)				
	IFSHP3636	IFSHP4036	IFSHP5036	IFSHP6036
3' - 11 3/4" (1213) 4' - 0" (1219) 3' - 11 1/2" (1207) 21 9/32" (541)				
	IFSHP3640	IFSHP4040	IFSHP5040	IFSHP6040
4' - 5 3/4" (1365) 4' - 6" (1372) 4' - 5 1/2" (1359) 24 9/32" (617)				
	IFSHP3646	IFSHP4046	IFSHP5046	IFSHP6046

GBG available in standard Rectangular lite cut shown.

* These windows meet National Egress Codes for fire evacuation. Local codes may differ.

Details and Elevations not to scale.

Obscure Glass option available on all units.

T = Standard Tempered

Special sized units available within product size matrix. See your Integrity® retailer.

MULTIPLE ASSEMBLIES

Multiple assemblies can be factory mullied up to 4 units wide by 1 unit high.

MAXIMUM ROUGH OPENING:
not to exceed 114" x 78" or up to 2 units wide by 2 units high.

MAXIMUM ROUGH OPENING:
not to exceed 96" x 96". Field mull kits are available. Structural mullion reinforcement is required for some assemblies.

Please consult your local Integrity from Marvin representative for more information.

SWINGING PICTURE AND TRANSOM UNITS

INTEGRITY® FROM MARVIN
ALL ULTREX® SERIES





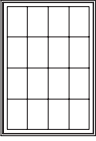
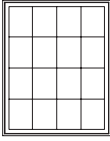
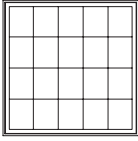
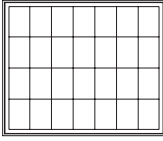
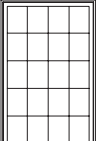
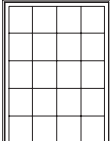
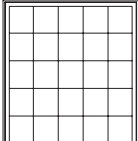
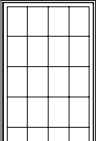
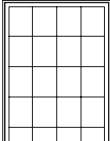
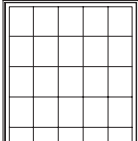







Picture Units

Masonry Opening	3' - 6" (1067)	4' - 0" (1219)	5' - 0" (1524)	6' - 0" (1829)
Rough Opening	3' - 6" (1067)	4' - 0" (1219)	5' - 0" (1524)	6' - 0" (1829)
Frame Size	3' - 5 1/2" (1054)	3' - 11 1/2" (1207)	4' - 11 1/2" (1511)	5' - 11 1/2" (1816)
Glass Size	37 17/32" (953)	43 17/32" (1106)	55 17/32" (1411)	

4' - 11 3/4" (1518)				
5' - 5 3/4" (1670)	IFSWP3650	IFSWP4050	IFSWP5050	IFSWP6050T
5' - 6" (1676)				
5' - 5 1/2" (1664)	IFSWP3656	IFSWP4056	IFSWP5056	
30 9/32" (789)				
5' - 11 3/4" (1822)	IFSWP3660T	IFSWP4060T	IFSWP5060T	
6' - 0" (1829)				
5' - 11 1/2" (1816)				
67 17/32" (1715)				

In-Sash Transom

Masonry Opening	1' - 6" (457)	2' - 0" (610)	2' - 6" (762)	3' - 0" (914)	3' - 6" (1067)	4' - 0" (1219)
Rough Opening	1' - 6" (457)	2' - 0" (610)	2' - 6" (762)	3' - 0" (914)	3' - 6" (1067)	4' - 0" (1219)
Frame Size	1' - 5 1/2" (445)	1' - 11 1/2" (597)	2' - 5 1/2" (749)	2' - 11 1/2" (902)	3' - 5 1/2" (1054)	3' - 11 1/2" (1207)
Glass Size	13 17/32" (344)	19 17/32" (496)	25 17/32" (649)	31 17/32" (801)	37 17/32" (953)	43 17/32" (1106)

0' - 11 3/4" (298)						
1' - 0" (305)	IFSWT1610	IFSWT2010	IFSWT2610	IFSWT3010	IFSWT3610	IFSWT4010
0' - 11 1/2" (292)						
1' - 5 3/4" (451)	IFSWT1616	IFSWT2016	IFSWT2616	IFSWT3016	IFSWT3616	IFSWT4016
1' - 6" (457)						
1' - 5 1/2" (445)						
13 17/32" (344)						

Construction Details

