













































DOUBLE HUNG

Operating Units – 18", 24", 30", 32", 36", 42", 48" Widths

Masonry Opening	1' - 6" (457)	2' - 0" (610)	2' - 6" (762)	2' - 8" (914)	3' - 0" (914)	3' - 6" (1067)	4' - 0" (1219)
Rough Opening	1' - 6" (457)	2' - 0" (610)	2' - 6" (762)	2' - 8" (914)	3' - 0" (914)	3' - 6" (1067)	4' - 0" (1219)
Frame Size	1' - 5 1/2" (445)	1' - 11 1/2" (597)	2' - 5 1/2" (749)	2' - 7 1/2" (902)	2' - 11 1/2" (902)	3' - 5 1/2" (1054)	3' - 11 1/2" (1207)
Class Size	13 17/32" (344)	19 17/32" (496)	25 17/32" (649)	27 17/32" (703)	31 17/32" (801)	37 17/32" (953)	43 17/32" (1106)

1' - 1 3/4" (603) 2' - 0" (610) 1' - 11 1/2" (597) 9' 9/32" (236)							
2' - 5 3/4" (756) 2' - 6" (762) 2' - 5 1/2" (749) 12 9/32" (312)							
2' - 11 3/4" (908) 3' - 0" (914) 2' - 11 1/2" (902) 15 9/32" (388)							
3' - 5 3/4" (1060) 3' - 6" (1067) 3' - 5 1/2" (1054) 18 9/32" (464)							
3' - 11 3/4" (1213) 4' - 0" (1219) 3' - 11 1/2" (1207) 21 9/32" (541)							
4' - 5 3/4" (1365) 4' - 6" (1372) 4' - 5 1/2" (1359) 24 9/32" (617)							
4' - 11 3/4" (1518) 5' - 0" (1524) 4' - 11 1/2" (1511) 27 9/32" (693)							

GBG available in standard Rectangular lite cut shown.

* These windows meet National Egress Codes for fire evacuation. Local codes may differ.

Details and Elevations not to scale.

■ / C = Cottage Style

Obscure Glass option available on all units.

Special sized units available within product size matrix. See your Integrity® retailer.

MULTIPLE ASSEMBLIES

Multiple assemblies can be factory mulled up to 4 units wide by 1 unit high.

MAXIMUM ROUGH OPENING:
not to exceed 114" x 78" or up to 2 units wide by 2 units high.

MAXIMUM ROUGH OPENING:
not to exceed 96" x 96". Field mull kits are available. Structural mullion reinforcement is required for some assemblies.

Please consult your local Integrity from Marvin representative for more information.

DOUBLE HUNG

INTEGRITY® FROM MARVIN
ALL ULTREX® SERIES

Operating Units – 18", 24", 30", 32", 36", 42", 48" Widths

Masonry Opening	1' - 6" (457)	2' - 0" (610)	2' - 6" (762)	2' - 8" (914)	3' - 0" (914)	3' - 6" (1067)	4' - 0" (1219)
Rough Opening	1' - 6" (457)	2' - 0" (610)	2' - 6" (762)	2' - 8" (914)	3' - 0" (914)	3' - 6" (1067)	4' - 0" (1219)
Frame Size	1' - 5 1/2" (445)	1' - 11 1/2" (597)	2' - 5 1/2" (749)	2' - 7 1/2" (902)	2' - 11 1/2" (902)	3' - 5 1/2" (1054)	3' - 11 1/2" (1207)
Glass Size	13 17/32" (344)	19 17/32" (496)	25 17/32" (649)	27 17/32" (703)	31 17/32" (801)	37 17/32" (953)	43 17/32" (1106)

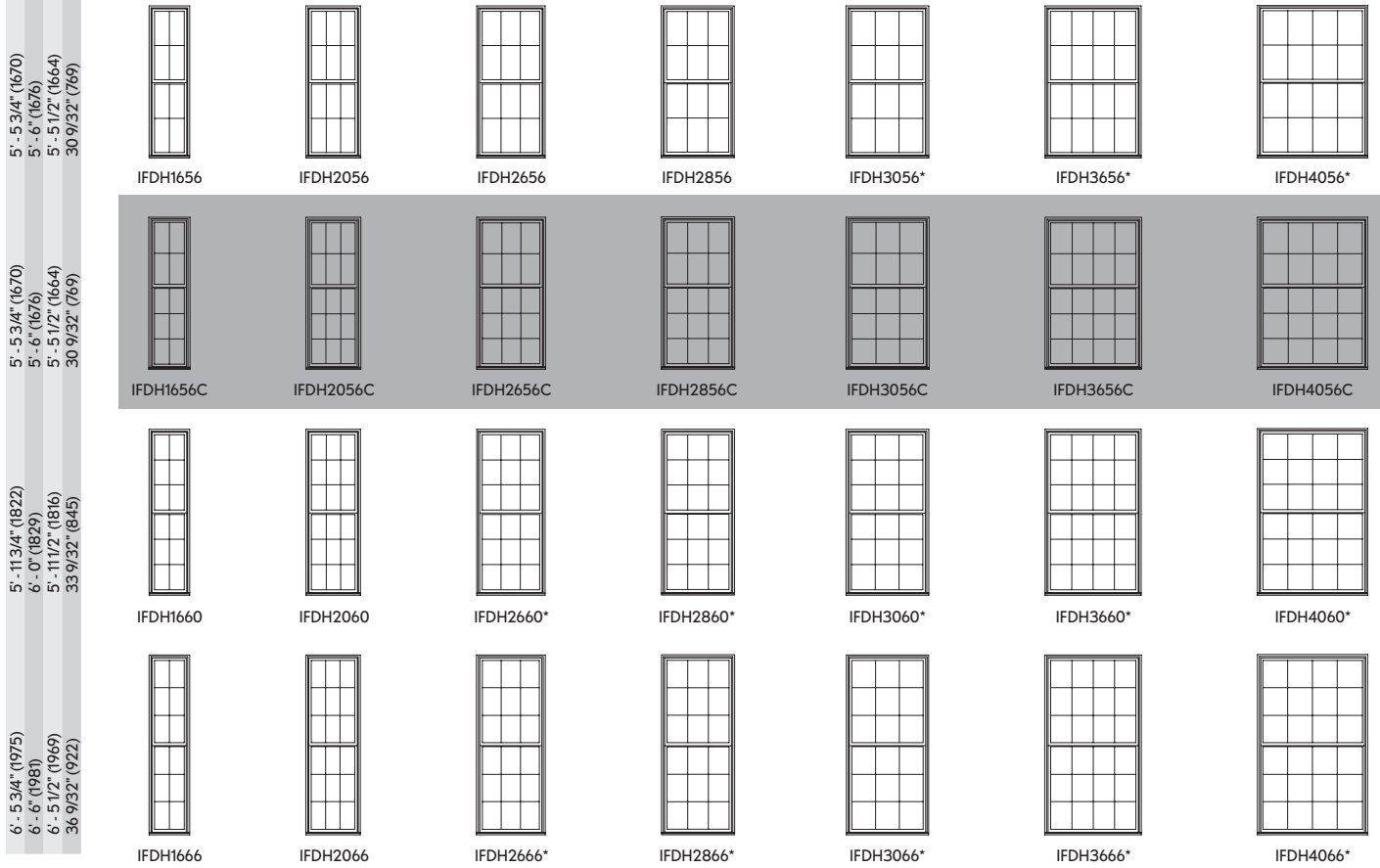



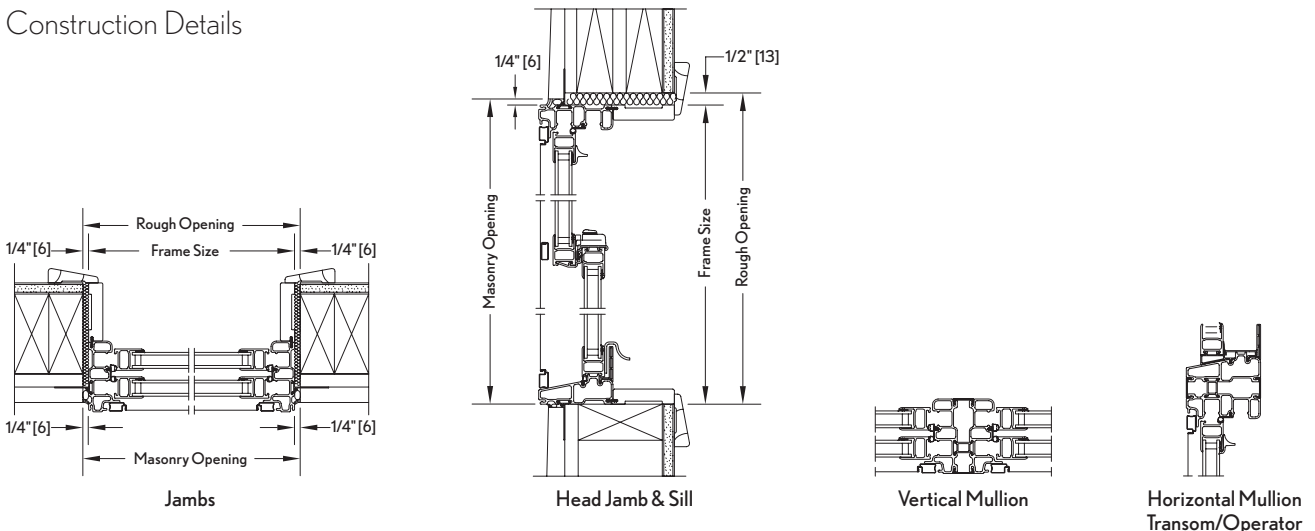









































Construction Details



DOUBLE HUNG

2 Wide Operating Units – 18", 24", 30", 32", 36", 42", 48" Widths

Masonry Opening	3' - 0" (914)	4' - 0" (1219)	5' - 0" (1524)	5' - 4" (1626)	6' - 0" (1829)	7' - 0" (2134)	8' - 0" (2438)
Rough Opening	3' - 0" (914)	4' - 0" (1219)	5' - 0" (1524)	5' - 4" (1626)	6' - 0" (1829)	7' - 0" (2134)	8' - 0" (2438)
Frame Size	2' - 11 1/2" (902)	3' - 11 1/2" (1207)	4' - 11 1/2" (1511)	5' - 3 1/2" (1600)	5' - 11 1/2" (1816)	6' - 11 1/2" (2121)	7' - 11 1/2" (2426)

1' - 11 3/4" (603) 2' - 0" (610) 1' - 11 1/2" (597)	 IFDH1620	 IFDH2020	 IFDH2620	 IFDH2820			
2' - 5 3/4" (756) 2' - 6" (762) 2' - 5 1/2" (749)	 IFDH1626	 IFDH2026	 IFDH2626	 IFDH2826	 IFDH3026	 IFDH3626	
2' - 11 3/4" (908) 3' - 0" (914) 2' - 11 1/2" (902)	 IFDH1630	 IFDH2030	 IFDH2630	 IFDH2830	 IFDH3030	 IFDH3630	 IFDH4030
3' - 5 3/4" (1060) 3' - 6" (1067) 3' - 5 1/2" (1054)	 IFDH1636	 IFDH2036	 IFDH2636	 IFDH2836	 IFDH3036	 IFDH3636	 IFDH4036
3' - 11 3/4" (1213) 4' - 0" (1219) 3' - 11 1/2" (1207)	 IFDH1640	 IFDH2040	 IFDH2640	 IFDH2840	 IFDH3040	 IFDH3640	 IFDH4040
4' - 5 3/4" (1365) 4' - 6" (1372) 4' - 5 1/2" (1359)	 IFDH1646	 IFDH2046	 IFDH2646	 IFDH2846	 IFDH3046	 IFDH3646	 IFDH4046
4' - 11 3/4" (1518) 5' - 0" (1524) 4' - 11 1/2" (1511)	 IFDH1650	 IFDH2050	 IFDH2650	 IFDH2850	 IFDH3050*	 IFDH3650*	 IFDH4050*

* These windows meet National Egress Codes for fire evacuation. Local codes may differ.

Details and Elevations not to scale.

■ / C = Cottage Style

Obscure Glass option available on all units.

Special sized units available within product size matrix. See your Integrity® retailer.

MULTIPLE ASSEMBLIES

Multiple assemblies can be factory mullered up to 4 units wide by 1 unit high.

MAXIMUM ROUGH OPENING:
not to exceed 114" x 78" or up to 2 units wide by 2 units high.

MAXIMUM ROUGH OPENING:
not to exceed 96" x 96". Field mull kits are available. Structural mullion reinforcement is required for some assemblies.

Please consult your local Integrity from Marvin representative for more information.

DOUBLE HUNG

INTEGRITY® FROM MARVIN
ALL ULTREX® SERIES

2 Wide Operating Units – 18", 24", 30", 32", 36", 42", 48" Widths

Masonry Opening	3' - 0" (914)	4' - 0" (1219)	5' - 0" (1524)	5' - 4" (1626)	6' - 0" (1829)	7' - 0" (2134)	8' - 0" (2438)
Rough Opening	3' - 0" (914)	4' - 0" (1219)	5' - 0" (1524)	5' - 4" (1626)	6' - 0" (1829)	7' - 0" (2134)	8' - 0" (2438)
Frame Size	2' - 11 1/2" (902)	3' - 11 1/2" (1207)	4' - 11 1/2" (1511)	5' - 3 1/2" (1600)	5' - 11 1/2" (1816)	6' - 11 1/2" (2121)	7' - 11 1/2" (2426)

5' - 5 3/4" (1670)
5' - 6" (1676)
5' - 5 1/2" (1664)

5' - 5 3/4" (1670)
5' - 6" (1676)
5' - 5 1/2" (1664)

5' - 11 3/4" (1822)
6' - 0" (1829)
5' - 11 1/2" (1816)

6' - 5 3/4" (1975)
6' - 6" (1981)
6' - 5 1/2" (1969)



IFDH1656



IFDH2056



IFDH2656

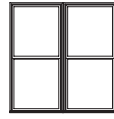

IFDH2856

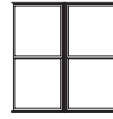

IFDH3056*

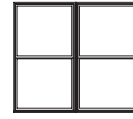

IFDH3656*

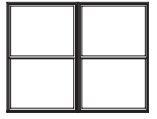

IFDH4056*



IFDH1656C



IFDH2056C



IFDH2656C

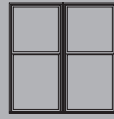

IFDH2856C

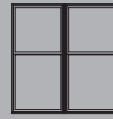

IFDH3056C

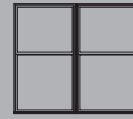

IFDH3656C

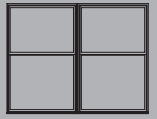

IFDH4056C



IFDH1660



IFDH2060



IFDH2660*

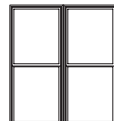

IFDH2860*

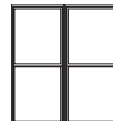

IFDH3060*

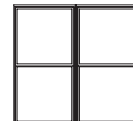

IFDH3660*



IFDH4060*



IFDH1666



IFDH2066



IFDH2666*



IFDH2866*

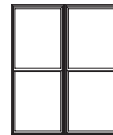

IFDH3066*

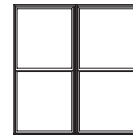

IFDH3666*





































IFDH4066*

DOUBLE HUNG

3 Wide Operating Units – 18", 24", 30", 32", 36" Widths

Masonry Opening	4' - 6" (1372)	6' - 0" (1829)	7' - 6" (2286)	8' - 0" (2438)	9' - 0" (2743)
Rough Opening	4' - 6" (1372)	6' - 0" (1829)	7' - 6" (2286)	8' - 0" (2438)	9' - 0" (2743)
Frame Size	4' - 5 1/2" (1359)	5' - 11 1/2" (1816)	7' 5 5/8" (2273)	7' 11 1/2" (2413)	8' - 11 1/2" (2731)

1' - 11 3/4" (603) 2' - 0" (610) 1' - 11 1/2" (597)	 IFDH1620	 IFDH2020	 IFDH2620	 IFDH2820	
2' - 5 3/4" (756) 2' - 6" (762) 2' - 5 1/2" (749)	 IFDH1626	 IFDH2026	 IFDH2626	 IFDH2826	 IFDH3026
2' - 11 3/4" (908) 3' - 0" (914) 2' - 11 1/2" (902)	 IFDH1630	 IFDH2030	 IFDH2630	 IFDH2830	 IFDH3030
3' - 5 3/4" (1060) 3' - 6" (1067) 3' - 5 1/2" (1054)	 IFDH1636	 IFDH2036	 IFDH2636	 IFDH2836	 IFDH3036
3' - 11 3/4" (1213) 4' - 0" (1219) 3' - 11 1/2" (1207)	 IFDH1640	 IFDH2040	 IFDH2640	 IFDH2840	 IFDH3040
4' - 5 3/4" (1365) 4' - 6" (1372) 4' - 5 1/2" (1359)	 IFDH1646	 IFDH2046	 IFDH2646	 IFDH2846	 IFDH3046
4' - 11 3/4" (1518) 5' - 0" (1524) 4' - 11 1/2" (1511)	 IFDH1650	 IFDH2050	 IFDH2650	 IFDH2850	 IFDH3050*

* These windows meet National Egress Codes for fire evacuation. Local codes may differ.

** This product is only available field mullled.

Details and Elevations not to scale.

■ / C = Cottage Style

Obscure Glass option available on all units.

Special sized units available within product size matrix. See your Integrity® retailer.

MULTIPLE ASSEMBLIES

Multiple assemblies can be factory mullled up to 4 units wide by 1 unit high.

MAXIMUM ROUGH OPENING:
not to exceed 114" x 78" or up to 2 units wide by 2 units high.

MAXIMUM ROUGH OPENING:
not to exceed 96" x 96". Field mull kits are available. Structural mullion reinforcement is required for some assemblies.

Please consult your local Integrity from Marvin representative for more information.













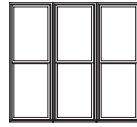
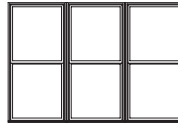
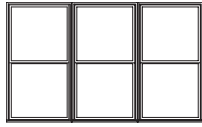





DOUBLE HUNG

INTEGRITY® FROM MARVIN
ALL ULTREX® SERIES

3 Wide Operating Units – 18", 24", 30", 32", 36" Widths

Masonry Opening	4' - 6" (1372)	6' - 0" (1829)	7' - 6" (2286)	8' - 0" (2438)	9' - 0" (2743)
Rough Opening	4' - 6" (1372)	6' - 0" (1829)	7' - 6" (2286)	8' - 0" (2438)	9' - 0" (2743)
Frame Size	4' - 5 1/2" (1359)	5' - 11 1/2" (1816)	7' 5 5/8" (2273)	7' 11 1/2" (2413)	8' - 11 1/2" (2731)























5' - 5 3/4" (1670)	5' - 5 3/4" (1670)	5' - 11 3/4" (1822)	6' - 5 3/4" (1975)
5' - 6" (1676)	5' - 6" (1676)	6' - 0" (1829)	6' - 6" (1981)
5' - 5 1/2" (1664)	5' - 5 1/2" (1664)	5' - 11 1/2" (1816)	6' - 5 1/2" (1969)

				
IFDH1656	IFDH2056	IFDH2656	IFDH2856	IFDH3056*
				
IFDH1656C	IFDH2056C	IFDH2656C	IFDH2856C	IFDH3056C
				
IFDH1660	IFDH2060	IFDH2660*	IFDH2860*	IFDH3060*
				
IFDH1666	IFDH2066	IFDH2666*	IFDH2866*	IFDH3066*

DOUBLE HUNG

4 Wide Operating Units – 72", 96" Widths

Masonry Opening	6'-0" (1829)	8'-0" (2438)
Rough Opening	6'-0" (1829)	8'-0" (2438)
Frame Size	5'-11 1/2" (1816)	7'-11 1/2" (2426)

1'-11 3/4" (603)		
2'-0" (600)	IFSH1620	IFSH2020
2'-5 3/4" (756)		
2'-6" (762)	IFSH1626	IFSH2026
2'-5 1/2" (749)		
2'-11 3/4" (908)	IFSH1630	IFSH2030
3'-0" (914)		
3'-5 3/4" (1060)	IFSH1636	IFSH2036
3'-6" (1067)		
3'-5 1/2" (1054)	IFSH1640	IFSH2040
3'-11 3/4" (1213)		
4'-0" (1219)	IFSH1646	IFSH2046
4'-5 3/4" (1365)		
4'-6" (1372)	IFSH1650	IFSH2050
4'-5 1/2" (1359)		
4'-11 3/4" (1518)	IFSH1656	IFSH2056
5'-0" (1524)		
4'-11 1/2" (1511)	IFSH1660	IFSH2060
5'-5 3/4" (1670)		
5'-6" (1676)	IFSH1666	IFSH2066
5'-5 1/2" (1664)		
5'-11 3/4" (1822)	IFSH1666	IFSH2066
6'-0" (1829)		
6'-5 1/2" (1969)		

In-Sash Transom Mullered Over Double Hung – Operating Unit

Masonry Opening	2' - 6" (762)
Rough Opening	2' - 6" (762)
Frame Size	2' - 5 1/2" (749)
Glass Size	25 17/32" (649)

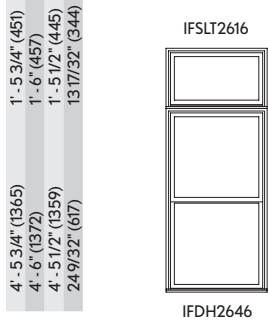

IFSLT2616

IFDH2646

In-Sash Transom Mullered Over Double Hung – 2 wide Operating Unit

Masonry Opening	5' - 0" (1524)	2' - 6" (762)
Rough Opening	5' - 0" (1524)	2' - 6" (762)
Frame Size	4' - 11 1/2" (1511)	2' - 5 1/2" (749)

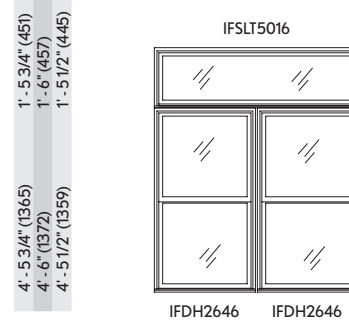

IFSLT5016

IFDH2646

IFDH2646

120" Flankers with Picture Unit Center**

Masonry Opening	2' - 6" (762)	5' - 0" (1524)	2' - 6" (762)
Rough Opening	2' - 6" (762)	5' - 0" (1524)	2' - 6" (762)
Frame Size	2' - 5 1/2" (749)	4' - 11 1/2" (1511)	2' - 5 1/2" (749)

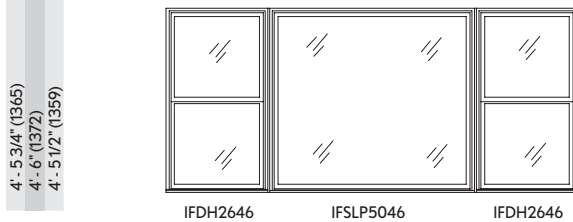

IFDH2646

IFSLP5046

IFDH2646

90" Flankers with Operator Unit Center

Masonry Opening	2' - 6" (762)	2' - 6" (762)	2' - 6" (762)
Rough Opening	2' - 6" (762)	2' - 6" (762)	2' - 6" (762)
Frame Size	2' - 5 1/2" (749)	2' - 5 1/2" (749)	2' - 5 1/2" (749)
Glass Size	25 17/32" (649)	25 17/32" (649)	25 17/32" (649)

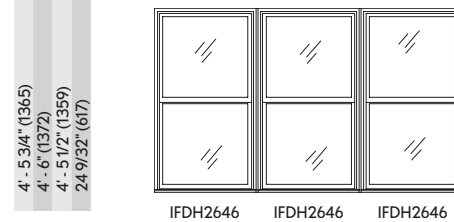

IFDH2646

IFDH2646

IFDH2646

* These windows meet National Egress Codes for fire evacuation. Local codes may differ.

** This product is only available field mullered.

Details and Elevations not to scale.

■ / C = Cottage Style

Obscure Glass option available on all units.

Special sized units available within product size matrix. See your Integrity retailer.

MULTIPLE ASSEMBLIES

Multiple assemblies can be factory mullered up to 4 units wide by 1 unit high.

MAXIMUM ROUGH OPENING:
not to exceed 114" x 78" or up to 2 units wide by 2 units high.

MAXIMUM ROUGH OPENING:
not to exceed 96" x 96". Field mull kits are available. Structural mullion reinforcement is required for some assemblies.

Please consult your local Integrity from Marvin representative for more information.

SLIDING PICTURE AND TRANSOM UNITS

INTEGRITY® FROM MARVIN
ALL ULTREX® SERIES

Picture Units

Masonry Opening	3' - 0" (914)	3' - 6" (1067)	4' - 0" (1219)	5' - 0" (1524)
Rough Opening	3' - 0" (914)	3' - 6" (1067)	4' - 0" (1219)	5' - 0" (1524)
Frame Size	2' - 11 1/2" (902)	3' - 5 1/2" (1054)	3' - 11 1/2" (1207)	4' - 11 1/2" (1511)
Glass Size	31 7/32" (801)	37 17/32" (953)	43 17/32" (1106)	55 17/32" (1411)

2' - 11 3/4" (908)				
3' - 0" (914)	IFSLP3030	IFSLP3630	IFSLP4030	IFSLP5030
2' - 11 1/2" (902)				
3' - 5 3/4" (1060)	IFSLP3036	IFSLP3636	IFSLP4036	IFSLP5036
3' - 6" (1067)				
3' - 5 1/2" (1054)	IFSLP3040	IFSLP3640	IFSLP4040	IFSLP5040
3' - 11 3/4" (1213)				
4' - 0" (1219)	IFSLP3046	IFSLP3646	IFSLP4046	IFSLP5046
3' - 11 1/2" (1207)				
43 17/32" (1106)	IFSLP3050	IFSLP3650	IFSLP4050	IFSLP5050
4' - 5 3/4" (1365)				
4' - 6" (1372)	IFSLP3056	IFSLP3656	IFSLP4056	IFSLP5056
4' - 5 1/2" (1358)				
49 17/32" (1258)	IFSLP3060	IFSLP3660	IFSLP4060	IFSLP5060
4' - 11 3/4" (1518)				
5' - 0" (1524)	IFSLP3070	IFSLP3670	IFSLP4070	IFSLP5070
4' - 11 1/2" (1511)				
55 17/32" (1411)	IFSLP3076	IFSLP3676	IFSLP4076	IFSLP5076
5' - 5 3/4" (1670)				
5' - 6" (1676)	IFSLP3080	IFSLP3680	IFSLP4080	IFSLP5080
5' - 5 1/2" (1664)				
61 7/32" (1563)	IFSLP3086	IFSLP3686	IFSLP4086	IFSLP5086
5' - 11 3/4" (1822)				
6' - 0" (1829)	IFSLP3090	IFSLP3690	IFSLP4090	IFSLP5090
5' - 11 1/2" (1816)				
67 7/32" (1715)	IFSLP3096	IFSLP3696	IFSLP4096	IFSLP5096

Construction Details

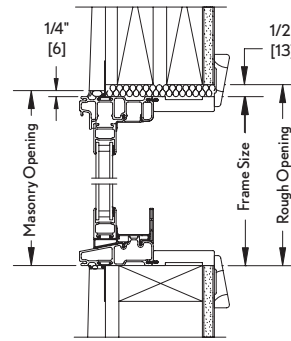

Head Jamb & Sill

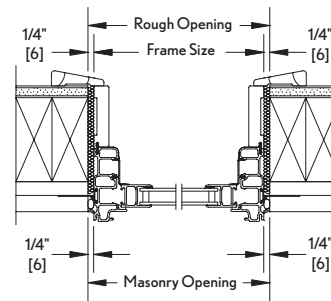

Jamb

GBG available in standard Rectangular lite cut, shown.

* These windows meet National Egress Codes for fire evacuation. Local codes may differ.

Details and Elevations not to scale.

MULTIPLE ASSEMBLIES

Multiple assemblies can be factory mullered up to 4 units wide by 1 unit high.

MAXIMUM ROUGH OPENING:
not to exceed 114" x 78" or up to 2 units wide by 2 units high.















MAXIMUM ROUGH OPENING:
not to exceed 96" x 96". Field mull kits are available. Structural mullion reinforcement is required for some assemblies.

Please consult your local Integrity from Marvin representative for more information.

SLIDING PICTURE AND TRANSOM UNITS

In-Sash Transom

Masonry Opening	1' - 6" (457)	2' - 0" (610)	2' - 6" (762)	2' - 8" (914)	3' - 0" (914)	3' - 6" (1067)	4' - 0" (1219)	5' - 0" (1524)
Rough Opening	1' - 6" (457)	2' - 0" (610)	2' - 6" (762)	2' - 8" (914)	3' - 0" (914)	3' - 6" (1067)	4' - 0" (1219)	5' - 0" (1524)
Frame Size	1' - 5 1/2" (445)	1' - 11 1/2" (597)	2' - 5 1/2" (749)	2' - 7 1/2" (902)	2' - 11 1/2" (902)	3' - 5 1/2" (1054)	3' - 11 1/2" (1207)	4' - 11 1/2" (1511)
Glass Size	13 17/32" (344)	19 17/32" (496)	25 17/32" (649)	27 11/16" (804)	31 17/32" (801)	37 17/32" (953)	43 17/32" (1106)	55 17/32" (1411)

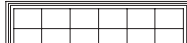
0' - 11 3/4" (298)								
IFSLT1610	IFSLT2010	IFSLT2610	IFSLT2810	IFSLT3010	IFSLT3610	IFSLT4010	IFSLT5010	
1' - 5 3/4" (451)								
IFSLT1616	IFSLT2016	IFSLT2616	IFSLT2816	IFSLT3016	IFSLT3616	IFSLT4016	IFSLT5016	

GBG available in standard Rectangular lite cut, shown.

* These windows meet National Egress Codes for fire evacuation. Local codes may differ.

Details and Elevations not to scale.

MULTIPLE ASSEMBLIES

Multiple assemblies can be factory mullied up to 4 units wide by 1 unit high.

MAXIMUM ROUGH OPENING:
not to exceed 114" x 78" or up to 2 units wide by 2 units high.

MAXIMUM ROUGH OPENING:
not to exceed 96" x 96". Field mull kits are available. Structural mullion reinforcement is required for some assemblies.

Please consult your local Integrity[®] from Marvin representative for more information.