

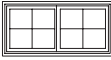

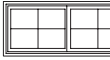

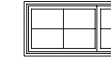

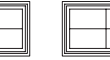

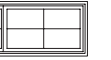
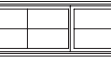









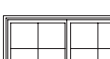







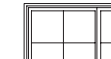





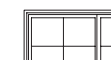















# GLIDER

Operating Units – 30", 36", 42", 48", 54", 60", 72" Widths

<b>Masonry Opening</b>	2' - 6" (762)	3' - 0" (914)	3' - 6" (1067)	4' - 0" (1219)	4' - 6" (1372)	5' - 0" (1524)	6' - 0" (1829)
<b>Rough Opening</b>	2' - 6" (762)	3' - 0" (914)	3' - 6" (1067)	4' - 0" (1219)	4' - 6" (1372)	5' - 0" (1524)	6' - 0" (1829)
<b>Frame Size</b>	2' - 5 1/2" (749)	2' - 11 1/2" (902)	3' - 5 1/2" (1054)	3' - 11 1/2" (1207)	4' - 5 1/2" (1359)	4' - 11 1/2" (1511)	5' - 11 1/2" (1816)
<b>Glass Size</b>	12 7/16" (316)	15 7/16" (392)	18 7/16" (468)	21 7/16" (545)	24 7/16" (621)	27 7/16" (697)	33 7/16" (849)

1' - 5 3/4" (451) 1' - 6" (457) 1' - 5 1/2" (445) 13 11/16" (347)							
IFGL2616	IFGL3016	IFGL3616	IFGL4016	IFGL4616	IFGL5016	IFGL6016	
1' - 11 3/4" (603) 2' - 0" (610) 1' - 11/2" (597) 19 11/16" (500)							
IFGL2620	IFGL3020	IFGL3620	IFGL4020	IFGL4620	IFGL5020	IFGL6020	
2' - 5 3/4" (756) 2' - 6" (762) 2' - 5 1/2" (749) 25 11/16" (652)							
IFGL2626	IFGL3026	IFGL3626	IFGL4026	IFGL4626	IFGL5026	IFGL6026	
2' - 11 3/4" (908) 3' - 0" (914) 2' - 11/2" (902) 31 11/16" (805)							
IFGL2630	IFGL3030	IFGL3630	IFGL4030	IFGL4630	IFGL5030	IFGL6030	
3' - 5 3/4" (1060) 3' - 6" (1067) 3' - 5 1/2" (1054) 37 11/16" (957)							
IFGL2636	IFGL3036	IFGL3636	IFGL4036	IFGL4636*	IFGL5036*	IFGL6036*	
3' - 11 3/4" (1213) 4' - 0" (1219) 3' - 11/2" (1207) 43 11/16" (1109)							
IFGL2640	IFGL3040	IFGL3640	IFGL4040*	IFGL4640*	IFGL5040*	IFGL6040*	
4' - 5 3/4" (1365) 4' - 6" (1372) 4' - 5 1/2" (1359) 49 11/16" (1262)							
IFGL2646	IFGL3046	IFGL3646	IFGL4046*	IFGL4646*	IFGL5046*	IFGL6046*	
4' - 11 3/4" (1518) 5' - 0" (1524) 4' - 11/2" (1511) 55 11/16" (1414)							
IFGL2650	IFGL3050	IFGL3650	IFGL4050*	IFGL4650*	IFGL5050*	IFGL6050*	

## Operating Units – 84", 96" Widths

<b>Masonry Opening</b>	2' - 6" (762)	3' - 0" (914)
<b>Rough Opening</b>	2' - 6" (762)	3' - 0" (914)
<b>Frame Size</b>	2' - 5 1/2" (749)	2' - 11 1/2" (902)
<b>Glass Size</b>	12 7/16" (316)	15 7/16" (392)

3' - 5 3/4" (1060)	3' - 11 3/4" (1213)	4' - 5 3/4" (1365)	4' - 11 3/4" (1518)
3' - 6" (1067)	4' - 0" (1216)	4' - 6" (1372)	5' - 0" (1524)
3' - 5 1/2" (1054)	3' - 11 1/2" (1207)	4' - 5 1/2" (1359)	4' - 11 1/2" (1511)
37 11/16" (957)	43 11/16" (1109)	49 11/16" (1262)	55 11/16" (1414)

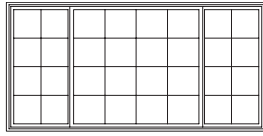

IFGL7036

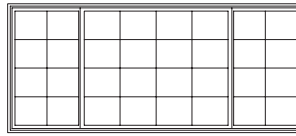

IFGL8036

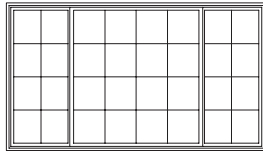

IFGL7040

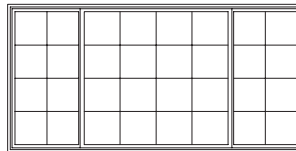

IFGL8040\*

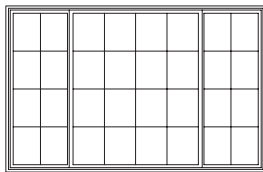

IFGL7046

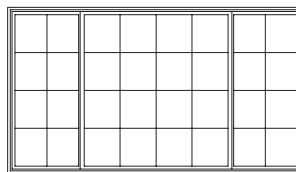

IFGL8046\*

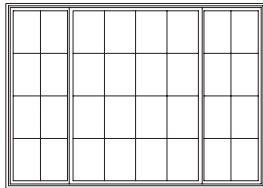

IFGL7050

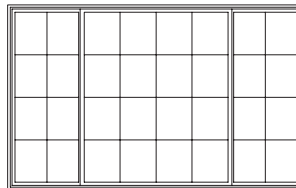

IFGL8050\*

GBG available in standard Rectangular lite cut shown.

\* These windows meet National Egress Codes for fire evacuation. Local codes may differ.

Details and Elevations not to scale.

Obscure Glass option available on all units.

Special sized units available within product size matrix. See your Integrity retailer.

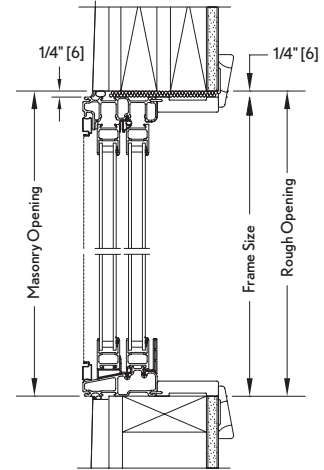

Head Jamb & Sill

## Construction Details

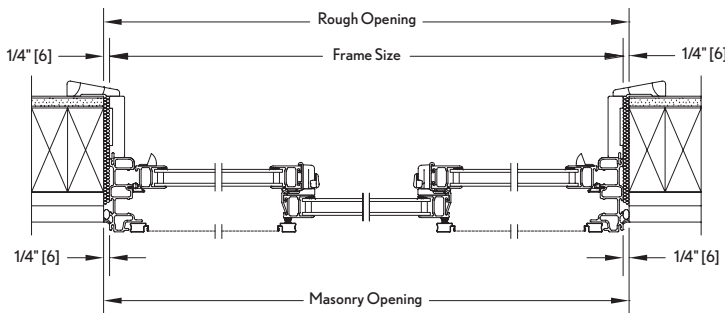

Triple Sash XOX Operator Jamb

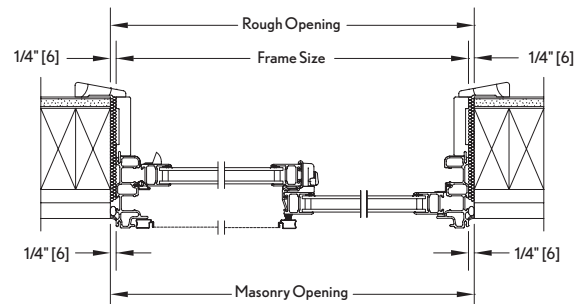





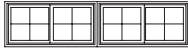

Jamb

# GLIDER

## 2 Wide Operating Units – 30", 36", 42", 48", 54" Widths

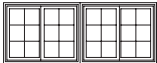
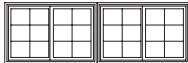
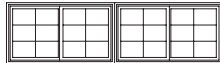
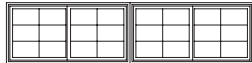
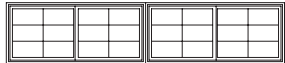
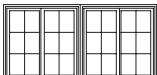
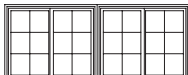
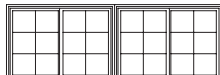
Masonry Opening	5' - 0" (1524)	6' - 0" (1828)	7' - 0" (2134)	8' - 0" (2438)	9' - 0" (2744)
Rough Opening	5' - 0" (1524)	6' - 0" (1828)	7' - 0" (2134)	8' - 0" (2438)	9' - 0" (2744)
Frame Size	4' - 11 1/2" (1511)	5' - 11 1/2" (1816)	6' - 11 1/2" (2121)	7' - 11 1/2" (2426)	8' - 11 1/2" (2734)

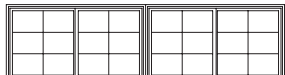
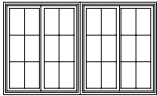
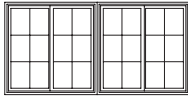
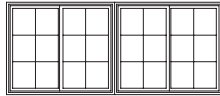
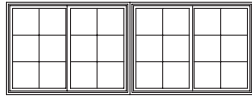
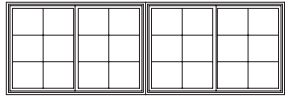
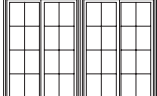
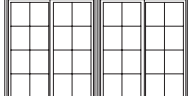
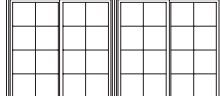
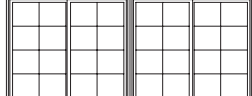
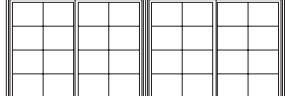
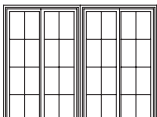
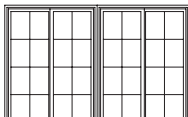
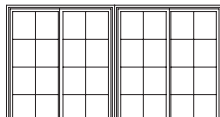
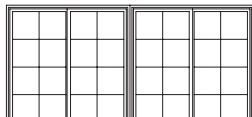
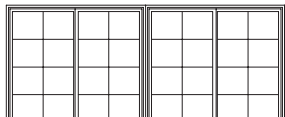
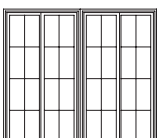
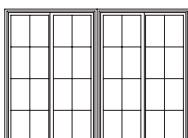
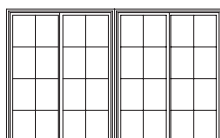
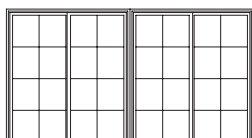
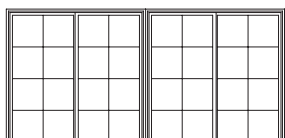
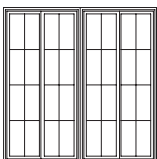
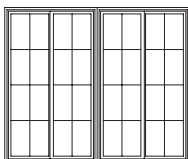
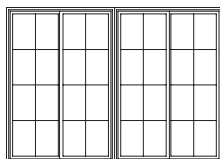
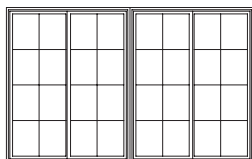
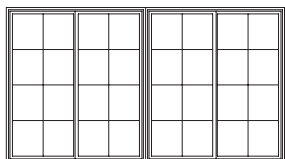
1' - 5 3/4" (451) 1' - 6" (457) 1' - 5 1/2" (445)	 IFGL2616	 IFGL3016	 IFGL3616	 IFGL4016	 IFGL4616
1' - 11 3/4" (603) 2' - 0" (610) 1' - 11 1/2" (597)	 IFGL2620	 IFGL3020	 IFGL3620	 IFGL4020	 IFGL4620
2' - 5 3/4" (756) 2' - 6" (762) 2' - 5 1/2" (749)	 IFGL2626	 IFGL3026	 IFGL3626	 IFGL4026	 IFGL4626
2' - 11 3/4" (908) 3' - 0" (914) 2' - 11 1/2" (902)	 IFGL2630	 IFGL3030	 IFGL3630	 IFGL4030	 IFGL4630
3' - 5 3/4" (1060) 3' - 6" (1067) 3' - 5 1/2" (1054)	 IFGL2636	 IFGL3036	 IFGL3636	 IFGL4036	 IFGL4636*
3' - 11 3/4" (1213) 4' - 0" (1219) 3' - 11 1/2" (1207)	 IFGL2640	 IFGL3040	 IFGL3640	 IFGL4040*	 IFGL4640*
4' - 5 3/4" (1365) 4' - 6" (1372) 4' - 5 1/2" (1359)	 IFGL2646	 IFGL3046	 IFGL3646	 IFGL4046*	 IFGL4646*
4' - 11 3/4" (1518) 5' - 0" (1524) 4' - 11 1/2" (1511)	 IFGL2650	 IFGL3050	 IFGL3650	 IFGL4050*	 IFGL4650*

GBG available in standard Rectangular cut shown.

\* These windows meet National Egress Codes for fire evacuation. Local codes may differ.

Details and Elevations not to scale.

Obscure Glass option available on all units.

Special sized units available within product size matrix. See your Integrity® retailer.

### MULTIPLE ASSEMBLIES

Multiple assemblies can be factory mulled up to 4 units wide by 1 unit high.

MAXIMUM ROUGH OPENING:  
not to exceed 114" x 60".

### Construction Details

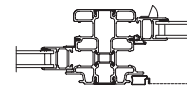

Vertical Mullion

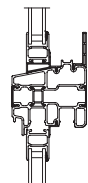

Horizontal Mullion

# SLIDING PICTURE AND TRANSOM UNITS

INTEGRITY® FROM MARVIN  
ALL ULTREX® SERIES

## Picture Units

Masonry Opening	3' - 0" (914)	3' - 6" (1067)	4' - 0" (1219)	5' - 0" (1524)
Rough Opening	3' - 0" (914)	3' - 6" (1067)	4' - 0" (1219)	5' - 0" (1524)
Frame Size	2' - 11 1/2" (902)	3' - 5 1/2" (1054)	3' - 11 1/2" (1207)	4' - 11 1/2" (1511)
Glass Size	31 7/32" (801)	37 17/32" (953)	43 17/32" (1106)	55 17/32" (1411)

2' - 11 3/4" (908)				
3' - 0" (914)	IFSLP3030	IFSLP3630	IFSLP4030	IFSLP5030
2' - 11 1/2" (902)				
3' - 5 3/4" (1060)	IFSLP3036	IFSLP3636	IFSLP4036	IFSLP5036
3' - 6" (1067)				
3' - 5 1/2" (1054)	IFSLP3040	IFSLP3640	IFSLP4040	IFSLP5040
3' - 11 3/4" (1213)				
4' - 0" (1219)	IFSLP3046	IFSLP3646	IFSLP4046	IFSLP5046
3' - 11 1/2" (1207)				
43 17/32" (1106)	IFSLP3050	IFSLP3650	IFSLP4050	IFSLP5050
4' - 5 3/4" (1365)				
4' - 6" (1372)	IFSLP3056	IFSLP3656	IFSLP4056	IFSLP5056
4' - 5 1/2" (1358)				
49 17/32" (1258)	IFSLP3060	IFSLP3660	IFSLP4060	IFSLP5060
4' - 11 3/4" (1518)				
5' - 0" (1524)	IFSLP3070	IFSLP3670	IFSLP4070	IFSLP5070
4' - 11 1/2" (1511)				
55 17/32" (1411)	IFSLP3076	IFSLP3676	IFSLP4076	IFSLP5076
5' - 5 3/4" (1670)				
5' - 6" (1676)	IFSLP3080	IFSLP3680	IFSLP4080	IFSLP5080
5' - 5 1/2" (1664)				
61 7/32" (1563)	IFSLP3086	IFSLP3686	IFSLP4086	IFSLP5086
5' - 11 3/4" (1822)				
6' - 0" (1829)	IFSLP3090	IFSLP3690	IFSLP4090	IFSLP5090
5' - 11 1/2" (1816)				
67 7/32" (1715)	IFSLP3096	IFSLP3696	IFSLP4096	IFSLP5096

## Construction Details

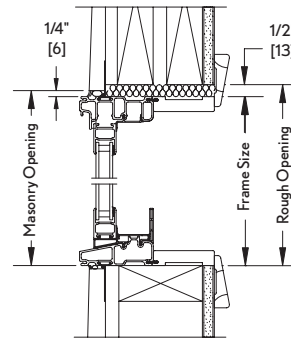

Head Jamb & Sill

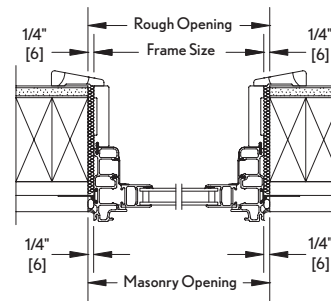

Jamb

GBG available in standard Rectangular lite cut, shown.

\* These windows meet National Egress Codes for fire evacuation. Local codes may differ.

Details and Elevations not to scale.

### MULTIPLE ASSEMBLIES

Multiple assemblies can be factory mull up to 4 units wide by 1 unit high.

**MAXIMUM ROUGH OPENING:**

not to exceed 114" x 78" or up to 2 units wide by 2 units high.

**MAXIMUM ROUGH OPENING:**















not to exceed 96" x 96". Field mull kits are available. Structural mullion reinforcement is required for some assemblies.

Please consult your local Integrity from Marvin representative for more information.

# SLIDING PICTURE AND TRANSOM UNITS

## In-Sash Transom

Masonry Opening	1' - 6" (457)	2' - 0" (610)	2' - 6" (762)	2' - 8" (914)	3' - 0" (914)	3' - 6" (1067)	4' - 0" (1219)	5' - 0" (1524)
Rough Opening	1' - 6" (457)	2' - 0" (610)	2' - 6" (762)	2' - 8" (914)	3' - 0" (914)	3' - 6" (1067)	4' - 0" (1219)	5' - 0" (1524)
Frame Size	1' - 5 1/2" (445)	1' - 11 1/2" (597)	2' - 5 1/2" (749)	2' - 7 1/2" (902)	2' - 11 1/2" (902)	3' - 5 1/2" (1054)	3' - 11 1/2" (1207)	4' - 11 1/2" (1511)
Glass Size	13 17/32" (344)	19 17/32" (496)	25 17/32" (649)	27 11/16" (804)	31 17/32" (801)	37 17/32" (953)	43 17/32" (1106)	55 17/32" (1411)

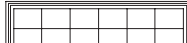
0' - 11 3/4" (298)								
IFSLT1610	IFSLT2010	IFSLT2610	IFSLT2810	IFSLT3010	IFSLT3610	IFSLT4010	IFSLT5010	
1' - 5 3/4" (451)								
IFSLT1616	IFSLT2016	IFSLT2616	IFSLT2816	IFSLT3016	IFSLT3616	IFSLT4016	IFSLT5016	

GBG available in standard Rectangular lite cut, shown.

\* These windows meet National Egress Codes for fire evacuation. Local codes may differ.

Details and Elevations not to scale.

### MULTIPLE ASSEMBLIES

Multiple assemblies can be factory mullied up to 4 units wide by 1 unit high.

**MAXIMUM ROUGH OPENING:**  
not to exceed 114" x 78" or up to 2 units wide by 2 units high.

**MAXIMUM ROUGH OPENING:**  
not to exceed 96" x 96". Field mull kits are available. Structural mullion reinforcement is required for some assemblies.

Please consult your local Integrity<sup>®</sup> from Marvin representative for more information.