













































SINGLE HUNG

Operating Units – 18", 24", 30", 32", 36", 42", 48" Widths

Masonry Opening	1' - 6" (457)	2' - 0" (610)	2' - 6" (762)	2' - 8" (914)	3' - 0" (914)	3' - 6" (1067)	4' - 0" (1219)
Rough Opening	1' - 6" (457)	2' - 0" (610)	2' - 6" (762)	2' - 8" (914)	3' - 0" (914)	3' - 6" (1067)	4' - 0" (1219)
Frame Size	1' - 5 1/2" (445)	1' - 11 1/2" (597)	2' - 5 1/2" (749)	2' - 7 1/2" (902)	2' - 11 1/2" (902)	3' - 5 1/2" (1054)	3' - 11 1/2" (1207)
Glass Size	13 17/32" (344)	19 17/32" (496)	25 17/32" (649)	27 17/32" (703)	31 17/32" (801)	37 17/32" (953)	43 17/32" (1106)

1' - 11 3/4" (603) 2' - 0" (610) 1' - 11 1/2" (597) 9' 9/32" (236)							
2' - 5 3/4" (756) 2' - 6" (762) 2' - 5 1/2" (749) 12' 9/32" (312)							
2' - 11 3/4" (908) 3' - 0" (914) 2' - 11 1/2" (902) 15' 9/32" (388)							
3' - 5 3/4" (1060) 3' - 6" (1067) 3' - 5 1/2" (1054) 18' 9/32" (464)							
3' - 11 3/4" (1213) 4' - 0" (1219) 3' - 11 1/2" (1207) 21' 9/32" (541)							
4' - 5 3/4" (1365) 4' - 6" (1372) 4' - 5 1/2" (1359) 24' 9/32" (617)							
4' - 11 3/4" (1518) 5' - 0" (1524) 4' - 11 1/2" (1511) 27' 9/32" (693)							

GBG available in standard Rectangular lite cut shown.

* These windows meet National Egress Codes for fire evacuation. Local codes may differ.

Details and Elevations not to scale.

■ / C = Cottage Style

Obscure Glass option available on all units.

Special sized units available within product size matrix. See your Integrity® retailer.

MULTIPLE ASSEMBLIES

Multiple assemblies can be factory mulled up to 4 units wide by 1 unit high.

MAXIMUM ROUGH OPENING:
not to exceed 114" x 78" or up to 2 units wide by 2 units high.

MAXIMUM ROUGH OPENING:
not to exceed 96" x 96". Field mull kits are available. Structural mullion reinforcement is required for some assemblies.

Please consult your local Integrity from Marvin representative for more information.

SINGLE HUNG

INTEGRITY® FROM MARVIN
ALL ULTREX® SERIES

Operating Units – 18", 24", 30", 32", 36", 42", 48" Widths

Masonry Opening	1' - 6" (457)	2' - 0" (610)	2' - 6" (762)	2' - 8" (914)	3' - 0" (914)	3' - 6" (1067)	4' - 0" (1219)
Rough Opening	1' - 6" (457)	2' - 0" (610)	2' - 6" (762)	2' - 8" (914)	3' - 0" (914)	3' - 6" (1067)	4' - 0" (1219)
Frame Size	1' - 5 1/2" (445)	1' - 11 1/2" (597)	2' - 5 1/2" (749)	2' - 7 1/2" (902)	2' - 11 1/2" (902)	3' - 5 1/2" (1054)	3' - 11 1/2" (1207)
Glass Size	13 17/32" (344)	19 17/32" (496)	25 17/32" (649)	27 17/32" (703)	31 17/32" (801)	37 17/32" (953)	43 17/32" (1106)

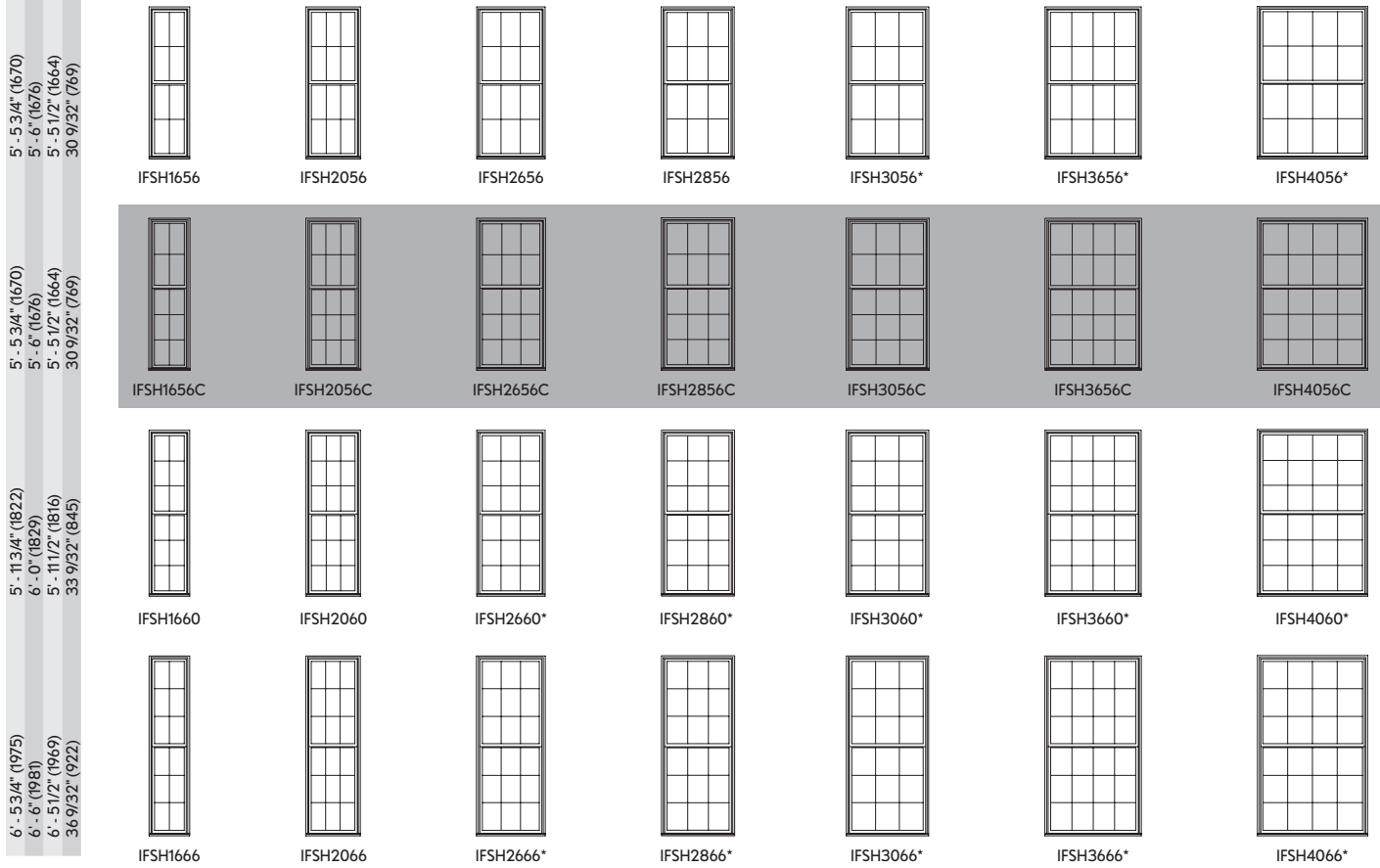



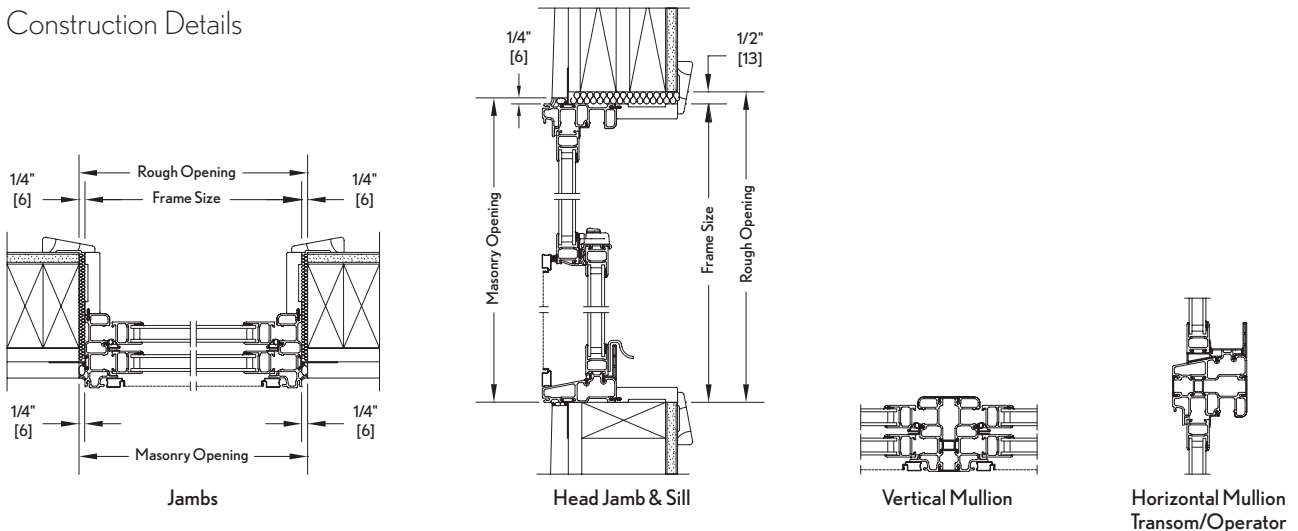









































Construction Details



SINGLE HUNG

2 Wide Operating Units – 18", 24", 30", 32", 36", 42", 48" Widths

Masonry Opening	3' - 0" (914)	4' - 0" (1219)	5' - 0" (1524)	5' - 4" (1626)	6' - 0" (1829)	7' - 0" (2134)	8' - 0" (2438)
Rough Opening	3' - 0" (914)	4' - 0" (1219)	5' - 0" (1524)	5' - 4" (1626)	6' - 0" (1829)	7' - 0" (2134)	8' - 0" (2438)
Frame Size	2' - 11 1/2" (902)	3' - 11 1/2" (1207)	4' - 11 1/2" (1511)	5' - 3 1/2" (1600)	5' - 11 1/2" (1816)	6' - 11 1/2" (2121)	7' - 11 1/2" (2426)

1' - 11 3/4" (603) 2' - 0" (610) 1' - 11 1/2" (597)	 IFSH1620	 IFSH2020	 IFSH2620	 IFSH2820			
2' - 5 3/4" (756) 2' - 6" (762) 2' - 5 1/2" (749)	 IFSH1626	 IFSH2026	 IFSH2626	 IFSH2826	 IFSH3026	 IFSH3626	
2' - 11 3/4" (908) 3' - 0" (914) 2' - 11 1/2" (902)	 IFSH1630	 IFSH2030	 IFSH2630	 IFSH2830	 IFSH3030	 IFSH3630	 IFSH4030
3' - 5 3/4" (1060) 3' - 6" (1067) 3' - 5 1/2" (1054)	 IFSH1636	 IFSH2036	 IFSH2636	 IFSH2836	 IFSH3036	 IFSH3636	 IFSH4036
3' - 11 3/4" (1213) 4' - 0" (1219) 3' - 11 1/2" (1207)	 IFSH1640	 IFSH2040	 IFSH2640	 IFSH2840	 IFSH3040	 IFSH3640	 IFSH4040
4' - 5 3/4" (1365) 4' - 6" (1372) 4' - 5 1/2" (1359)	 IFSH1646	 IFSH2046	 IFSH2646	 IFSH2846	 IFSH3046	 IFSH3646	 IFSH4046
4' - 11 3/4" (1518) 5' - 0" (1524) 4' - 11 1/2" (1511)	 IFSH1650	 IFSH2050	 IFSH2650	 IFSH2850	 IFSH3050*	 IFSH3650*	 IFSH4050*

* These windows meet National Egress Codes for fire evacuation. Local codes may differ.

Details and Elevations not to scale.

■ / C = Cottage Style

Obscure Glass option available on all units.

Special sized units available within product size matrix. See your Integrity® retailer.

MULTIPLE ASSEMBLIES

Multiple assemblies can be factory mulled up to 4 units wide by 1 unit high.

MAXIMUM ROUGH OPENING:
not to exceed 114" x 78" or up to 2 units wide by 2 units high.

MAXIMUM ROUGH OPENING:
not to exceed 96" x 96". Field mull kits are available. Structural mullion reinforcement is required for some assemblies.

















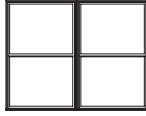







Please consult your local Integrity from Marvin representative for more information.

SINGLE HUNG

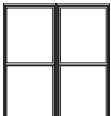
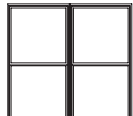
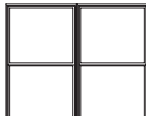
INTEGRITY® FROM MARVIN
ALL ULTREX® SERIES

2 Wide Operating Units – 18", 24", 30", 32", 36", 42", 48" Widths



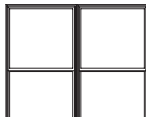









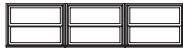



















Masonry Opening	3' - 0" (914)	4' - 0" (1219)	5' - 0" (1524)	5' - 4" (1626)	6' - 0" (1829)	7' - 0" (2134)	8' - 0" (2438)
Rough Opening	3' - 0" (914)	4' - 0" (1219)	5' - 0" (1524)	5' - 4" (1626)	6' - 0" (1829)	7' - 0" (2134)	8' - 0" (2438)
Frame Size	2' - 11 1/2" (902)	3' - 11 1/2" (1207)	4' - 11 1/2" (1511)	5' - 3 1/2" (1600)	5' - 11 1/2" (1816)	6' - 11 1/2" (2121)	7' - 11 1/2" (2426)

5' - 5 3/4" (1670) 5' - 6" (1676) 5' - 5 1/2" (1664)							
	IFSH1656	IFSH2056	IFSH2656	IFSH2856	IFSH3056*	IFSH3656*	IFSH4056*
5' - 5 3/4" (1670) 5' - 6" (1676) 5' - 5 1/2" (1664)							
	IFSH1656C	IFSH2056C	IFSH2656C	IFSH2856C	IFSH3056C	IFSH3656C	IFSH4056C
5' - 11 3/4" (1822) 6' - 0" (1829) 5' - 11 1/2" (1816)							
	IFSH1660	IFSH2060	IFSH2660*	IFSH2860*	IFSH3060*	IFSH3660*	IFSH4060*
6' - 5 3/4" (1975) 6' - 6" (1981) 6' - 5 1/2" (1969)							
	IFSH1666	IFSH2066	IFSH2666*	IFSH2866*	IFSH3066*	IFSH3666*	IFSH4066*

SINGLE HUNG

3 Wide Operating Units – 18", 24", 30", 32", 36" Widths

Masonry Opening	4' - 6" (1372)	6' - 0" (1829)	7' - 6" (2286)	8' - 0" (2438)	9' - 0" (2743)
Rough Opening	4' - 6" (1372)	6' - 0" (1829)	7' - 6" (2286)	8' - 0" (2438)	9' - 0" (2743)
Frame Size	4' - 5 1/2" (1359)	5' - 11 1/2" (1816)	7' - 5 1/2" (2273)	7' - 11 1/2" (2413)	8' - 11 1/2" (2731)

1' - 11 3/4" (603) 2' - 0" (610) 1' - 11 1/2" (597)	 IFSH1620	 IFSH2020	 IFSH2620	 IFSH2820	
2' - 5 3/4" (756) 2' - 6" (762) 2' - 5 1/2" (749)	 IFSH1626	 IFSH2026	 IFSH2626	 IFSH2826	 IFSH3026
2' - 11 3/4" (908) 3' - 0" (914) 2' - 11 1/2" (902)	 IFSH1630	 IFSH2030	 IFSH2630	 IFSH2830	 IFSH3030
3' - 5 3/4" (1060) 3' - 6" (1067) 3' - 5 1/2" (1054)	 IFSH1636	 IFSH2036	 IFSH2636	 IFSH2836	 IFSH3036
3' - 11 3/4" (1213) 4' - 0" (1219) 3' - 11 1/2" (1207)	 IFSH1640	 IFSH2040	 IFSH2640	 IFSH2840	 IFSH3040
4' - 5 3/4" (1365) 4' - 6" (1372) 4' - 5 1/2" (1359)	 IFSH1646	 IFSH2046	 IFSH2646	 IFSH2846	 IFSH3046
4' - 11 3/4" (1518) 5' - 0" (1524) 4' - 11 1/2" (1511)	 IFSH1650	 IFSH2050	 IFSH2650	 IFSH2850	 IFSH3050*

* These windows meet National Egress Codes for fire evacuation. Local codes may differ.

** This product is only available field mullled.

Details and Elevations not to scale.

■ / C = Cottage Style

Obscure Glass option available on all units.

Special sized units available within product size matrix. See your Integrity® retailer.

MULTIPLE ASSEMBLIES

Multiple assemblies can be factory mullled up to 4 units wide by 1 unit high.

MAXIMUM ROUGH OPENING:
not to exceed 114" x 78" or up to 2 units wide by 2 units high.

MAXIMUM ROUGH OPENING:
not to exceed 96" x 96". Field mull kits are available. Structural mullion reinforcement is required for some assemblies.

Please consult your local Integrity from Marvin representative for more information.

SINGLE HUNG

INTEGRITY® FROM MARVIN
ALL ULTREX® SERIES

3 Wide Operating Units – 18", 24", 30", 32", 36" Widths

Masonry Opening	4' - 6" (1372)	6' - 0" (1829)	7' - 6" (2286)	8' - 0" (2438)	9' - 0" (2743)
Rough Opening	4' - 6" (1372)	6' - 0" (1829)	7' - 6" (2286)	8' - 0" (2438)	9' - 0" (2743)
Frame Size	4' - 5 1/2" (1359)	5' - 11 1/2" (1816)	7' - 5 1/2" (2273)	7' 11 1/2" (2413)	8' - 11 1/2" (2731)

5' - 5 3/4" (1670)
5' - 6" (1676)
5' - 5 1/2" (1664)

5' - 5 3/4" (1670)
5' - 6" (1676)
5' - 5 1/2" (1664)

5' - 11 3/4" (1822)
6' - 0" (1829)
5' - 11 1/2" (1816)

6' - 5 3/4" (1975)
6' - 6" (1981)
6' - 5 1/2" (1969)



IFSH1656



IFSH2056

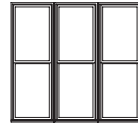

IFSH2656

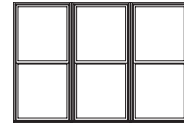

IFSH2856

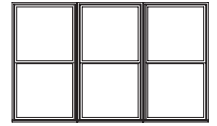

IFSH3056*



IFSH1656C



IFSH2056C



IFSH2656C



IFSH2856C



IFSH3056C



IFSH1660



IFSH2060

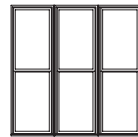

IFSH2660*

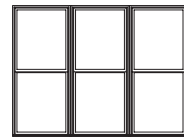

IFSH2860*

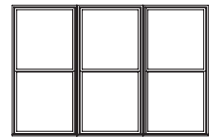

IFSH3060*



IFSH1666



IFSH2066

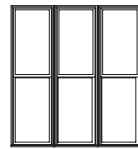

IFSH2666*

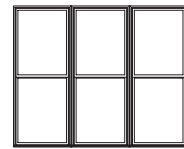

IFSH2866*

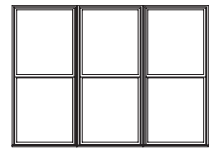













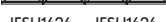







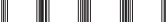

















IFSH3066*

SINGLE HUNG

4 Wide Operating Units – 72", 96" Widths

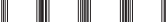
Masonry Opening	6'-0" (1829)	8'-0" (2438)
Rough Opening	6'-0" (1829)	8'-0" (2438)
Frame Size	5'-11 1/2" (1816)	7'-11 1/2" (2426)

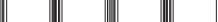
1'-11 3/4" (603) 2'-0" (610) 1'-11 1/2" (597)				
IFSH1620	IFSH1620		IFSH2020	IFSH1620
2'-5 3/4" (756) 2'-6" (762) 2'-5 1/2" (749)				
IFSH1626	IFSH1626		IFSH2026	IFSH2026
2'-11 3/4" (908) 3'-0" (914) 2'-11 1/2" (902)				
IFSH1630	IFSH1630		IFSH2030	IFSH2030
3'-5 3/4" (1060) 3'-6" (1067) 3'-5 1/2" (1054)				
IFSH1636	IFSH1636		IFSH2036	IFSH2036
3'-11 3/4" (1213) 4'-0" (1219) 3'-11 1/2" (1207)				
IFSH1640	IFSH1640		IFSH2040	IFSH2040
4'-5 3/4" (1365) 4'-6" (1372) 4'-5 1/2" (1359)				
IFSH1646	IFSH1646		IFSH2046	IFSH2046
4'-11 3/4" (1518) 5'-0" (1524) 4'-11 1/2" (1511)				
IFSH1650	IFSH1650		IFSH2050	IFSH2050
5'-5 3/4" (1670) 5'-6" (1676) 5'-5 1/2" (1664)				
IFSH1656	IFSH1656		IFSH2056	IFSH2056
5'-11 3/4" (1822) 6'-0" (1829) 5'-11 1/2" (1816)				
IFSH1660	IFSH1660		IFSH2060	IFSH2060
6'-5 3/4" (1975) 6'-6" (1981) 6'-5 1/2" (1969)				
IFSH1666	IFSH1666		IFSH2066	IFSH2066

In-Sash Transom Mullered Over Single Hung – Operating Unit

Masonry Opening	2' - 6" (762)
Rough Opening	2' - 6" (762)
Frame Size	2' - 5 1/2" (749)
Glass Size	25 17/32" (649)

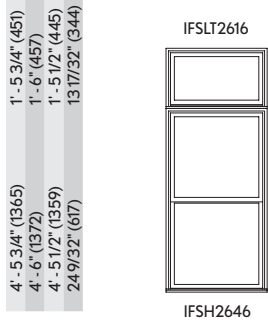

In-Sash Transom Mullered Over Single Hung – 2 wide Operating Unit

Masonry Opening	5' - 0" (1524)	2' - 6" (762)
Rough Opening	5' - 0" (1524)	2' - 6" (762)
Frame Size	4' - 11 1/2" (1511)	2' - 5 1/2" (749)

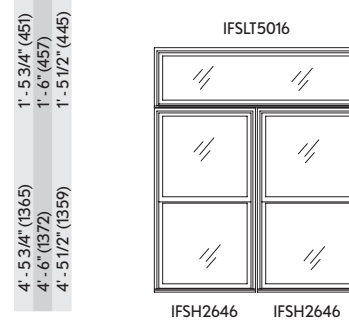

120" Flankers with Picture Unit Center**

Masonry Opening	2' - 6" (762)	5' - 0" (1524)	2' - 6" (762)
Rough Opening	2' - 6" (762)	5' - 0" (1524)	2' - 6" (762)
Frame Size	2' - 5 1/2" (749)	4' - 11 1/2" (1511)	2' - 5 1/2" (749)

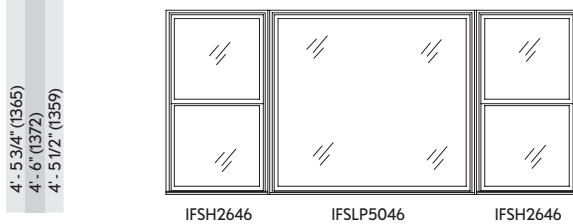

90" Flankers with Operator Unit Center

Masonry Opening	2' - 6" (762)	2' - 6" (762)	2' - 6" (762)
Rough Opening	2' - 6" (762)	2' - 6" (762)	2' - 6" (762)
Frame Size	2' - 5 1/2" (749)	2' - 5 1/2" (749)	2' - 5 1/2" (749)
Glass Size	25 17/32" (649)	25 17/32" (649)	25 17/32" (649)

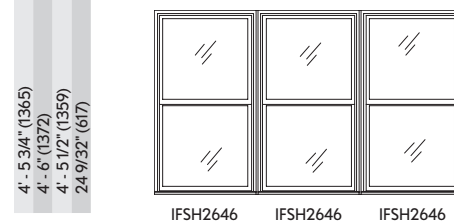

* These windows meet National Egress Codes for fire evacuation. Local codes may differ.

** This product is only available field mullered.

Details and Elevations not to scale.

Obscure Glass option available on all units.

Special sized units available within product size matrix. See your Integrity retailer.

MULTIPLE ASSEMBLIES

Multiple assemblies can be factory mullered up to 4 units wide by 1 unit high.

MAXIMUM ROUGH OPENING:
not to exceed 114" x 78" or up to 2 units wide by 2 units high.

MAXIMUM ROUGH OPENING:
not to exceed 96" x 96". Field mull kits are available. Structural mullion reinforcement is required for some assemblies.

Please consult your local Integrity from Marvin representative for more information.

SLIDING PICTURE AND TRANSOM UNITS

INTEGRITY® FROM MARVIN
ALL ULTREX® SERIES

Picture Units

Masonry Opening	3' - 0" (914)	3' - 6" (1067)	4' - 0" (1219)	5' - 0" (1524)
Rough Opening	3' - 0" (914)	3' - 6" (1067)	4' - 0" (1219)	5' - 0" (1524)
Frame Size	2' - 11 1/2" (902)	3' - 5 1/2" (1054)	3' - 11 1/2" (1207)	4' - 11 1/2" (1511)
Glass Size	31 7/32" (801)	37 17/32" (953)	43 17/32" (1106)	55 17/32" (1411)

2' - 11 3/4" (908)				
3' - 0" (914)	IFSLP3030	IFSLP3630	IFSLP4030	IFSLP5030
2' - 11 1/2" (902)				
3' - 5 3/4" (1060)	IFSLP3036	IFSLP3636	IFSLP4036	IFSLP5036
3' - 6" (1067)				
3' - 5 1/2" (1054)	IFSLP3040	IFSLP3640	IFSLP4040	IFSLP5040
3' - 11 3/4" (1213)				
4' - 0" (1219)	IFSLP3046	IFSLP3646	IFSLP4046	IFSLP5046
3' - 11 1/2" (1207)				
43 17/32" (1106)	IFSLP3050	IFSLP3650	IFSLP4050	IFSLP5050
4' - 5 3/4" (1365)				
4' - 6" (1372)	IFSLP3056	IFSLP3656	IFSLP4056	IFSLP5056
4' - 5 1/2" (1358)				
49 17/32" (1258)	IFSLP3060	IFSLP3660	IFSLP4060	IFSLP5060
4' - 11 3/4" (1518)				
5' - 0" (1524)	IFSLP3070	IFSLP3670	IFSLP4070	IFSLP5070
4' - 11 1/2" (1511)				
55 17/32" (1411)	IFSLP3076	IFSLP3676	IFSLP4076	IFSLP5076
5' - 5 3/4" (1670)				
5' - 6" (1676)	IFSLP3082	IFSLP3682	IFSLP4082	IFSLP5082
5' - 5 1/2" (1664)				
61 7/32" (1563)	IFSLP3088	IFSLP3688	IFSLP4088	IFSLP5088
5' - 11 3/4" (1822)				
6' - 0" (1829)	IFSLP3094	IFSLP3694	IFSLP4094	IFSLP5094
5' - 11 1/2" (1816)				
67 7/32" (1715)	IFSLP3098	IFSLP3698	IFSLP4098	IFSLP5098

Construction Details

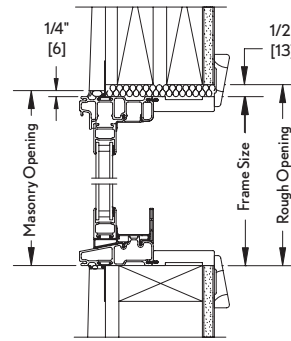

Head Jamb & Sill

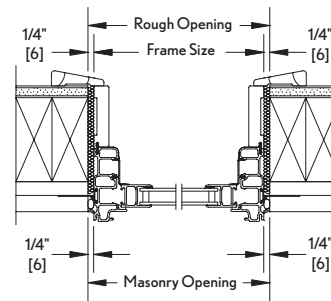

Jamb

GBG available in standard Rectangular lite cut, shown.

* These windows meet National Egress Codes for fire evacuation. Local codes may differ.

Details and Elevations not to scale.

MULTIPLE ASSEMBLIES

Multiple assemblies can be factory mull up to 4 units wide by 1 unit high.

MAXIMUM ROUGH OPENING:

not to exceed 114" x 78" or up to 2 units wide by 2 units high.

MAXIMUM ROUGH OPENING:















not to exceed 96" x 96". Field mull kits are available. Structural mullion reinforcement is required for some assemblies.

Please consult your local Integrity from Marvin representative for more information.

SLIDING PICTURE AND TRANSOM UNITS

In-Sash Transom

Masonry Opening	1' - 6" (457)	2' - 0" (610)	2' - 6" (762)	2' - 8" (914)	3' - 0" (914)	3' - 6" (1067)	4' - 0" (1219)	5' - 0" (1524)
Rough Opening	1' - 6" (457)	2' - 0" (610)	2' - 6" (762)	2' - 8" (914)	3' - 0" (914)	3' - 6" (1067)	4' - 0" (1219)	5' - 0" (1524)
Frame Size	1' - 5 1/2" (445)	1' - 11 1/2" (597)	2' - 5 1/2" (749)	2' - 7 1/2" (902)	2' - 11 1/2" (902)	3' - 5 1/2" (1054)	3' - 11 1/2" (1207)	4' - 11 1/2" (1511)
Glass Size	13 17/32" (344)	19 17/32" (496)	25 17/32" (649)	27 11/16" (804)	31 17/32" (801)	37 17/32" (953)	43 17/32" (1106)	55 17/32" (1411)

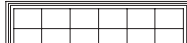
0' - 11 3/4" (298)								
IFSLT1610	IFSLT2010	IFSLT2610	IFSLT2810	IFSLT3010	IFSLT3610	IFSLT4010	IFSLT5010	
1' - 5 3/4" (451)								
IFSLT1616	IFSLT2016	IFSLT2616	IFSLT2816	IFSLT3016	IFSLT3616	IFSLT4016	IFSLT5016	

GBG available in standard Rectangular lite cut, shown.

* These windows meet National Egress Codes for fire evacuation. Local codes may differ.

Details and Elevations not to scale.

MULTIPLE ASSEMBLIES

Multiple assemblies can be factory mullied up to 4 units wide by 1 unit high.

MAXIMUM ROUGH OPENING:
not to exceed 114" x 78" or up to 2 units wide by 2 units high.

MAXIMUM ROUGH OPENING:
not to exceed 96" x 96". Field mull kits are available. Structural mullion reinforcement is required for some assemblies.

Please consult your local Integrity® from Marvin representative for more information.