

























































Operator Units

Mas. Opg. (mm)	1-10 (559)	2-2 (660)	2-6 (762)	2-10 (864)	3-0 (914)	3-2 (965)	3-6 (1067)
Rgh. Opg. (mm)	1-10 1/2 (572)	2-2 1/2 (673)	2-6 1/2 (775)	2-10 1/2 (876)	3-0 1/2 (927)	3-2 1/2 (978)	3-6 1/2 (1080)
Frame Size (mm)	1-9 1/2 (546)	2-1 1/2 (648)	2-5 1/2 (749)	2-9 1/2 (851)	2-11 1/2 (902)	3-1 1/2 (953)	3-5 1/2 (1054)
Glass Size (mm)	16 3/4" (425)	20 3/4" (527)	24 3/4" (629)	28 3/4" (730)	30 3/4" (781)	32 3/4" (832)	36 3/4" (933)

3-0 (914)							
3-0 (914)	(S.O. 1-8 x 2-10)	(S.O. 2-0 x 2-10)	(S.O. 2-4 x 2-10)	(S.O. 2-8 x 2-10)	(S.O. 2-10 x 2-10)	(S.O. 3-0 x 2-10)	(S.O. 3-4 x 2-10)
3-0 1/4 (921)							
3-0 1/4 (921)	(S.O. 1-8 x 3-2)	(S.O. 2-0 x 3-2)	(S.O. 2-4 x 3-2)	(S.O. 2-8 x 3-2)	(S.O. 2-10 x 3-2)	(S.O. 3-0 x 3-2)	(S.O. 3-4 x 3-2)
3-3/4 (908)							
3-3/4 (908)	(S.O. 1-8 x 3-10)	(S.O. 2-0 x 3-10)	(S.O. 2-4 x 3-10)	(S.O. 2-8 x 3-10)	(S.O. 2-10 x 3-10)	(S.O. 3-0 x 3-10)	(S.O. 3-4 x 3-10)
14 3/4 (375)							
14 3/4 (375)	(S.O. 1-8 x 4-2)	(S.O. 2-0 x 4-2)	(S.O. 2-4 x 4-2)	(S.O. 2-8 x 4-2)	(S.O. 2-10 x 4-2)	(S.O. 3-0 x 4-2)	(S.O. 3-4 x 4-2)
4-0 (1016)							
4-0 (1016)	(S.O. 1-8 x 4-6)	(S.O. 2-0 x 4-6)	(S.O. 2-4 x 4-6)	(S.O. 2-8 x 4-6)	(S.O. 2-10 x 4-6)	(S.O. 3-0 x 4-6)	(S.O. 3-4 x 4-6)
4-0 1/4 (1022)							
4-0 1/4 (1022)	(S.O. 1-8 x 4-10)	(S.O. 2-0 x 4-10)	(S.O. 2-4 x 4-10)	(S.O. 2-8 x 4-10)	(S.O. 2-10 x 4-10)	(S.O. 3-0 x 4-10)	(S.O. 3-4 x 4-10)
4-3/4 (1213)							
4-3/4 (1213)	(S.O. 1-8 x 5-2)	(S.O. 2-0 x 5-2)	(S.O. 2-4 x 5-2)	(S.O. 2-8 x 5-2)	(S.O. 2-10 x 5-2)	(S.O. 3-0 x 5-2)	(S.O. 3-4 x 5-2)
20 3/4 (527)							
20 3/4 (527)	(S.O. 1-8 x 5-2)	(S.O. 2-0 x 5-2)	(S.O. 2-4 x 5-2)	(S.O. 2-8 x 5-2)	(S.O. 2-10 x 5-2)	(S.O. 3-0 x 5-2)	(S.O. 3-4 x 5-2)

Details and Elevations not to scale.

When ordering 6-9/16" (167 mm) jambs, add 1/4" (6 mm) to width and 1/8" (3 mm) to height for Rough Opening, Frame Size and Masonry Opening.

Optional wood interior Grilles available in standard rectangular lite cut shown.

Optional SDL lite cuts available in several popular configurations, contact your local Integrity from Marvin retailer for details.

* These windows meet National Egress Codes for fire evacuation. Local codes may differ.

 = Obscure Glass Available

Construction Details

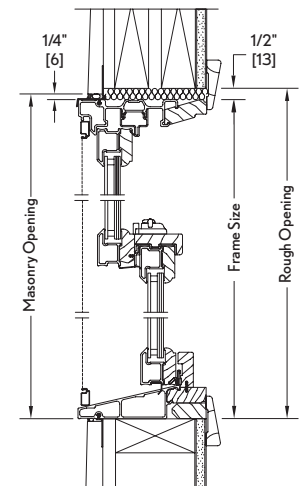

Operator Head Jamb and Sill

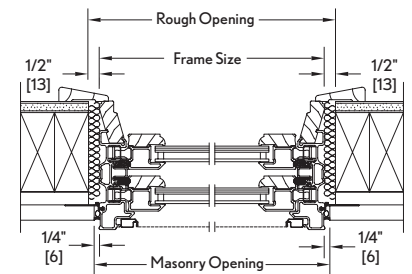

Operator Jamb

DOUBLE HUNG

Operator Units

Mas. Opp. (mm)	1-10 (559)	2-2 (660)	2-6 (762)	2-10 (864)	3-0 (914)	3-2 (965)
Rgh. Opp. (mm)	1-10 1/2 (572)	2-2 1/2 (673)	2-6 1/2 (775)	2-10 1/2 (876)	3-0 1/2 (927)	3-2 1/2 (978)
Frame Size (mm)	1-9 1/2 (546)	2-1 1/2 (648)	2-5 1/2 (749)	2-9 1/2 (851)	2-11 1/2 (902)	3-1 1/2 (953)
Glass Size (mm)	16 3/4" (425)	20 3/4" (527)	24 3/4" (629)	28 3/4" (730)	30 3/4" (781)	32 3/4" (832)

5-8 (727) 5-8 1/4 (734) 5-7 3/4 (721) 36 3/4" (933) 24 3/4" (629)	(S.O. 1-8 x 5-6) ITDH2268C	(S.O. 2-0 x 5-6) ITDH2668C	(S.O. 2-4 x 5-6) ITDH3068C	(S.O. 2-8 x 5-6) ITDH3468C	(S.O. 2-10 x 5-6) ITDH3668C	(S.O. 3-0 x 5-6) ITDH3868C
6-0 (1829) 6-0 1/4 (1835) 5-11 3/4 (1822) 32 3/4" (832)	(S.O. 1-8 x 5-10) ITDH2272	(S.O. 2-0 x 5-10) ITDH2672	(S.O. 2-4 x 5-10) ITDH3072	(S.O. 2-8 x 5-10) ITDH3472*	(S.O. 2-10 x 5-10) ITDH3672*	(S.O. 3-0 x 5-10) ITDH3872*
6-4 (1930) 6-4 1/4 (1937) 6-3 3/4 (1924) 34 3/4" (883)	(S.O. 1-8 x 6-2) ITDH2276	(S.O. 2-0 x 6-2) ITDH2676	(S.O. 2-4 x 6-2) ITDH3076*	(S.O. 2-8 x 6-2) ITDH3476*	(S.O. 2-10 x 6-2) ITDH3676*	(S.O. 3-0 x 6-2) ITDH3876*

Details and Elevations not to scale.

When ordering 6-9/16" (167 mm) jambs, add 1/4" (6 mm) to width and 1/8" (3 mm) to height for Rough Opening, Frame Size and Masonry Opening.

Optional wood interior Grilles available in standard rectangular lite cut shown.

Optional SDL lite cuts available in several popular configurations, contact your local Integrity from Marvin retailer for details.

* These windows meet National Egress Codes for fire evacuation. Local codes may differ.

■ / C = Cottage Style

In-Sash Transom and Picture Units

Mas. Opp. (mm)	1-10 (559)	2-2 (660)	2-6 (762)	2-10 (864)
Rgh. Opp. (mm)	1-10 1/2 (572)	2-2 1/2 (673)	2-6 1/2 (775)	2-10 1/2 (876)
Frame Size (mm)	1-9 1/2 (546)	2-1 1/2 (648)	2-5 1/2 (749)	2-9 1/2 (851)
Glass Size (mm)	16 3/4" (425)	20 3/4" (527)	24 3/4" (629)	28 3/4" (730)

1-4 (406) 1-4 1/4 (413) 1-3 3/4 (400) 10 3/4" (273)	 ITDHR2216T	 ITDHR2616T	 ITDHR3016T	 ITDHR3416T
--	----------------	----------------	----------------	----------------

Mas. Opp. (mm)	3-0 (914)	3-2 (965)	3-6 (1067)
Rgh. Opp. (mm)	3-0 1/2 (927)	3-2 1/2 (978)	3-6 1/2 (1080)
Frame Size (mm)	2-11 1/2 (902)	3-1 1/2 (953)	3-5 1/2 (1054)
Glass Size (mm)	30 3/4" (781)	32 3/4" (832)	36 3/4" (933)

1-4 (406) 1-4 1/4 (413) 1-3 3/4 (400) 10 3/4" (273)	 ITDHR3616T	 ITDHR3816T	 ITDHR4216T
--	----------------	----------------	----------------

Details and Elevations not to scale.

T = Standard Tempered

When ordering 6-9/16" (167 mm) or 6-13/16" (173 mm) jambs, add 1/4" (6 mm) to width and 1/8" (3 mm) to height for Rough Opening, Frame Size and Masonry Opening.

Optional wood interior Grilles available in standard rectangular lite cut shown.

Optional SDL lite cuts available in several popular configurations, contact your local Integrity from Marvin retailer for details.

DOUBLE HUNG PICTURE

Picture Units

Mas. Opg. (mm)	3-2 (965)	3-6 (1067)	4-2 (1270)	4-6 (1372)	5-2 (1575)
Rgh. Opg. (mm)	3-2 1/2 (978)	3-6 1/2 (1080)	4-2 1/2 (1283)	4-6 1/2 (1384)	5-2 1/2 (1588)
Frame Size (mm)	3-1 1/2 (953)	3-5 1/2 (1054)	4-1 1/2 (1257)	4-5 1/2 (1359)	5-1 1/2 (1562)
Glass Size (mm)	32 3/4" (832)	36 3/4" (933)	44 3/4" (1137)	48 3/4" (1238)	56 3/4" (1441)

3-4 (1016) 3-4 1/4 (1022) 3-3 3/4 (1010) 34 3/4" (885)					
4-0 (1219) 4-0 1/4 (1226) 3-11 3/4 (1213) 42 3/4" (1086)					
4-4 (1321) 4-4 1/4 (1327) 4-3 3/4 (1314) 46 3/4" (1187)					
4-8 (1422) 4-8 1/4 (1429) 4-7 3/4 (1416) 50 3/4" (1289)					
5-0 (1524) 5-0 1/4 (1530) 4-11 3/4 (1518) 54 3/4" (1391)					
5-4 (1626) 5-4 1/4 (1632) 5-3 3/4 (1619) 58 3/4" (1492)					
5-8 (1727) 5-8 1/4 (1734) 5-7 3/4 (1721) 62 3/4" (1594)					
6-0 (1829) 6-0 1/4 (1835) 5-11 3/4 (1822) 66 3/4" (1695)					
6-4 (1930) 6-4 1/4 (1937) 6-3 3/4 (1924) 70 3/4" (1797)					

Details and Elevations not to scale.

T = Standard Tempered

Optional wood interior Grilles available in standard rectangular lite cut shown.

Optional SDL lite cuts available in several popular configurations, contact your local Integrity from Marvin retailer for details.

Construction Details

