

































































DOUBLE HUNG

INTEGRITY® FROM MARVIN®
WOOD-ULTREX® SERIES

Operator Units

Mas. Opg. (mm)	1-10 (559)	2-2 (660)	2-6 (762)	2-8 (813)	2-10 (864)	3-0 (914)	3-2 (965)	3-6 (1067)
Rgh. Opg. (mm)	1-10 1/2 (572)	2-2 1/2 (673)	2-6 1/2 (775)	2-8 1/2 (826)	2-10 1/2 (876)	3-0 1/2 (927)	3-2 1/2 (978)	3-6 1/2 (1080)
Frame Size (mm)	1-9 1/2 (546)	2-1 1/2 (648)	2-5 1/2 (749)	2-7 1/2 (800)	2-9 1/2 (851)	2-11 1/2 (902)	3-1 1/2 (953)	3-5 1/2 (1054)
Glass Size (mm)	16 3/4" (425)	20 3/4" (527)	24 3/4" (629)	26 3/4" (679)	28 3/4" (730)	30 3/4" (781)	32 3/4" (832)	36 3/4" (933)

3-0 (914) 3-0 1/4 (921) 2-11 3/4 (908) 14 3/4 (375)	 ITDH2236 (S.O. 1-8 x 2-10)	 ITDH2636 (S.O. 2-0 x 2-10)	 ITDH3036 (S.O. 2-4 x 2-10)	 ITDH3236 (S.O. 2-6 x 2-10)	 ITDH3436 (S.O. 2-8 x 2-10)	 ITDH3636 (S.O. 2-10 x 2-10)	 ITDH3836 (S.O. 3-0 x 2-10)	 ITDH4236 (S.O. 3-4 x 2-10)
3-4 (1016) 3-4 1/4 (1022) 3-3 3/4 (1010) 16 3/4 (425)	 ITDH2240 (S.O. 1-8 x 3-2)	 ITDH2640 (S.O. 2-0 x 3-2)	 ITDH3040 (S.O. 2-4 x 3-2)	 ITDH3240 (S.O. 2-6 x 3-2)	 ITDH3440 (S.O. 2-8 x 3-2)	 ITDH3640 (S.O. 2-10 x 3-2)	 ITDH3840 (S.O. 3-0 x 3-2)	 ITDH4240 (S.O. 3-4 x 3-2)
3-8 (1176) 3-8 1/4 (1124) 3-7 3/4 (1111) 18 3/4 (476)	 ITDH2244 (S.O. 1-8 x 3-6)	 ITDH2644 (S.O. 1-8 x 3-6)	 ITDH3044 (S.O. 1-8 x 3-6)	 ITDH3244 (S.O. 1-8 x 3-6)	 ITDH3444 (S.O. 1-8 x 3-6)	 ITDH3644 (S.O. 1-8 x 3-6)	 ITDH3844 (S.O. 1-8 x 3-6)	 ITDH4244 (S.O. 1-8 x 3-6)
4-0 (1219) 4-0 1/4 (1226) 3-11 3/4 (1213) 20 3/4 (527)	 ITDH2248 (S.O. 1-8 x 3-10)	 ITDH2648 (S.O. 2-0 x 3-10)	 ITDH3048 (S.O. 2-4 x 3-10)	 ITDH3248 (S.O. 2-6 x 3-10)	 ITDH3448 (S.O. 2-8 x 3-10)	 ITDH3648 (S.O. 2-10 x 3-10)	 ITDH3848 (S.O. 3-0 x 3-10)	 ITDH4248 (S.O. 3-4 x 3-10)
4-4 (1321) 4-4 1/4 (1327) 4-3 3/4 (1314) 22 3/4 (578)	 ITDH2252 (S.O. 1-8 x 4-2)	 ITDH2652 (S.O. 2-0 x 4-2)	 ITDH3052 (S.O. 2-4 x 4-2)	 ITDH3252 (S.O. 2-6 x 4-2)	 ITDH3452 (S.O. 2-8 x 4-2)	 ITDH3652 (S.O. 2-10 x 4-2)	 ITDH3852 (S.O. 3-0 x 4-2)	 ITDH4252 (S.O. 3-4 x 4-2)
4-8 (1422) 4-8 1/4 (1429) 4-7 3/4 (1416) 24 3/4 (629)	 ITDH2256 (S.O. 1-8 x 4-6)	 ITDH2656 (S.O. 2-0 x 4-6)	 ITDH3056 (S.O. 2-4 x 4-6)	 ITDH3256 (S.O. 2-6 x 4-6)	 ITDH3456 (S.O. 2-8 x 4-6)	 ITDH3656 (S.O. 2-10 x 4-6)	 ITDH3856* (S.O. 3-0 x 4-6)	 ITDH4256* (S.O. 3-4 x 4-6)
5-0 (1524) 5-0 1/4 (1530) 4-11 3/4 (1518) 26 3/4 (679)	 ITDH2260 (S.O. 1-8 x 4-10)	 ITDH2660 (S.O. 2-0 x 4-10)	 ITDH3060 (S.O. 2-4 x 4-10)	 ITDH3260 (S.O. 2-6 x 4-10)	 ITDH3460 (S.O. 2-8 x 4-10)	 ITDH3660* (S.O. 2-10 x 4-10)	 ITDH3860* (S.O. 3-0 x 4-10)	 ITDH4260* (S.O. 3-4 x 4-10)
5-4 (1626) 5-4 1/4 (1632) 5-3 3/4 (1619) 28 3/4 (730)	 ITDH2264 (S.O. 1-8 x 5-2)	 ITDH2664 (S.O. 2-0 x 5-2)	 ITDH3064 (S.O. 2-4 x 5-2)	 ITDH3264* (S.O. 2-6 x 5-2)	 ITDH3464* (S.O. 2-8 x 5-2)	 ITDH3664* (S.O. 2-10 x 5-2)	 ITDH3864* (S.O. 3-0 x 5-2)	 ITDH4264* (S.O. 3-4 x 5-2)

Details and Elevations not to scale.

Optional Double Hung Grilles, GBGs and SDLs are available in a standard Rectangular cut shown.

















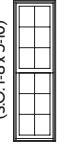

When ordering 6 9/16" (167 mm) jambs, add 1/4" (6 mm) to width and 1/8" (3 mm) to height for Rough Opening, Frame Size and Masonry Opening.

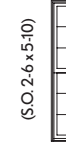
* These windows meet National Egress Codes for fire evacuation. Local codes may differ.

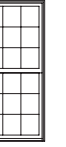
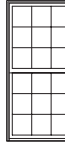
DOUBLE HUNG

Operator Units

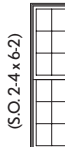
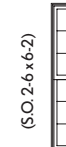
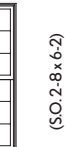
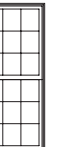
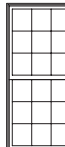
Mas. Opp. (mm)	1-10 (559)	2-2 (660)	2-6 (762)	2-8 (813)	2-10 (864)	3-0 (914)	3-2 (965)	3-6 (1067)
Rgh. Opp. (mm)	1-10 1/2 (572)	2-2 1/2 (673)	2-6 1/2 (775)	2-8 1/2 (826)	2-10 1/2 (876)	3-0 1/2 (927)	3-2 1/2 (978)	3-6 1/2 (1080)
Frame Size (mm)	1-9 1/2 (546)	2-1 1/2 (648)	2-5 1/2 (749)	2-7 1/2 (800)	2-9 1/2 (851)	2-11 1/2 (902)	3-1 1/2 (953)	3-5 1/2 (1054)
Glass Size (mm)	16 3/4" (425)	20 3/4" (527)	24 3/4" (629)	26 3/4" (679)	28 3/4" (730)	30 3/4" (781)	32 3/4" (832)	36 3/4" (933)

5-8 (1727) 5-8 1/4 (1734) 5-7 3/4 (1721) 30 3/4" (781)	 ITDH2268 (S.O. 1-8 x 5-6)	 ITDH2668 (S.O. 2-0 x 5-6)	 ITDH3068* (S.O. 2-4 x 5-6)	 ITDH3268* (S.O. 2-6 x 5-6)	 ITDH3468* (S.O. 2-8 x 5-6)	 ITDH3668* (S.O. 2-10 x 5-6)	 ITDH3868* (S.O. 3-0 x 5-6)	 ITDH4268* (S.O. 3-4 x 5-6)
6-0 (1829) 6-0 1/4 (1835) 5-11 3/4 (1822) 32 3/4" (832)	 ITDH2272 (S.O. 1-8 x 5-10)	 ITDH2672 (S.O. 2-0 x 5-10)	 ITDH3072* (S.O. 2-4 x 5-10)	 ITDH3272* (S.O. 2-6 x 5-10)	 ITDH3472* (S.O. 2-8 x 5-10)	 ITDH3672* (S.O. 2-10 x 5-10)	 ITDH3872* (S.O. 3-0 x 5-10)	 ITDH4272* (S.O. 3-4 x 5-10)
6-4 (1930) 6-4 1/4 (1937) 6-3 3/4 (1924) 34 3/4" (883)	 ITDH2276 (S.O. 1-8 x 6-2)	 ITDH2676 (S.O. 2-0 x 6-2)	 ITDH3076* (S.O. 2-4 x 6-2)	 ITDH3276* (S.O. 2-6 x 6-2)	 ITDH3476* (S.O. 2-8 x 6-2)	 ITDH3676* (S.O. 2-10 x 6-2)	 ITDH3876* (S.O. 3-0 x 6-2)	 ITDH4276* (S.O. 3-4 x 6-2)

Details and Elevations not to scale.

Optional Double Hung Grilles, GBGs and SDLs are available in a standard Rectangular cut shown.

When ordering 6 9/16" (167 mm) jambs, add 1/4" (6 mm) to width and 1/8" (3 mm) to height for Rough Opening, Frame Size and Masonry Opening.

* These windows meet National Egress Codes for fire evacuation. Local codes may differ.

■ = Available in Cottage Style with unequal sash. Cottage Style Glass size (min) 36 3/4" (933) / 24 3/4" (629).

2 Wide Operator Units

Mas. Opp. (mm)	3-7 1/2 (1105)	4-3 1/2 (1308)	4-11 1/2 (1511)	5-3 1/2 (1613)	5-7 1/2 (1715)	5-11 1/2 (1816)	6-3 1/2 (1918)	6-11 1/2 (2121)
Rgh. Opp. (mm)	3-8 (1118)	4-4 (1321)	5-0 (1524)	5-4 (1626)	5-8 (1727)	6-0 (1829)	6-4 (1930)	7-0 (2134)
Frame Size (mm)	3-7 (1092)	4-3 (1295)	4-11 (1499)	5-3 (1600)	5-7 (1702)	5-11 (1803)	6-3 (1905)	6-11 (2108)

3-0 (914) 3-0 1/4 (921) 2-11 3/4 (908)	 ITDH2236 2W	 ITDH2636 2W	 ITDH3036 2W	 ITDH3236 2W	 ITDH3436 2W	 ITDH3636 2W	 ITDH3836 2W	 ITDH4236 2W
3-4 (1016) 3-4 1/4 (1022) 3-3 3/4 (1010)	 ITDH2240 2W	 ITDH2640 2W	 ITDH3040 2W	 ITDH3240 2W	 ITDH3440 2W	 ITDH3640 2W	 ITDH3840 2W	 ITDH4240 2W
3-8 (1176) 3-8 1/4 (1124) 3-7 3/4 (1111)	 ITDH2244 2W	 ITDH2644 2W	 ITDH3044 2W	 ITDH3244 2W	 ITDH3444 2W	 ITDH3644 2W	 ITDH3844 2W	 ITDH4244 2W
4-0 (1219) 4-0 1/4 (1226) 3-11 3/4 (1213)	 ITDH2248 2W	 ITDH2648 2W	 ITDH3048 2W	 ITDH3248 2W	 ITDH3448 2W	 ITDH3648 2W	 ITDH3848 2W	 ITDH4248 2W

DOUBLE HUNG

INTEGRITY® FROM MARVIN®
WOOD-ULTREX® SERIES

2 Wide Operator Units

Mas. Opg. (mm)	3-7 1/2 (1105)	4-3 1/2 (1308)	4-11 1/2 (1511)	5-3 1/2 (1613)	5-7 1/2 (1715)	5-11 1/2 (1816)	6-3 1/2 (1918)	6-11 1/2 (2121)
Rgh. Opg. (mm)	3-8 (1118)	4-4 (1321)	5-0 (1524)	5-4 (1626)	5-8 (1727)	6-0 (1829)	6-4 (1930)	7-0 (2134)
Frame Size (mm)	3-7 (1092)	4-3 (1295)	4-11 (1499)	5-3 (1600)	5-7 (1702)	5-11 (1803)	6-3 (1905)	6-11 (2108)

4-4 (1321)
4-4 1/4 (1327)
4-3 3/4 (1314)

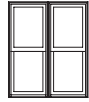

ITDH2252 2W

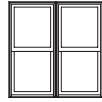

ITDH2652 2W

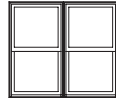

ITDH3052 2W

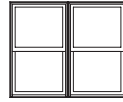

ITDH3252 2W

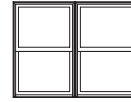

ITDH3452 2W

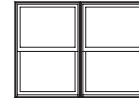

ITDH3652 2W

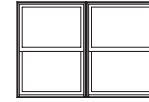

ITDH3852 2W

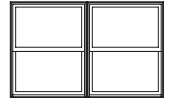

ITDH4252 2W

4-8 (1422)
4-8 1/4 (1429)
4-7 3/4 (1416)

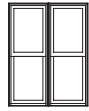

ITDH2256 2W

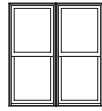

ITDH2656 2W

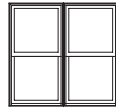

ITDH3056 2W

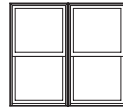

ITDH3256 2W

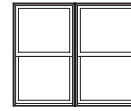

ITDH3456 2W

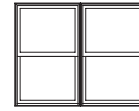

ITDH3656 2W

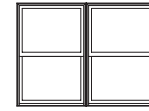

ITDH3856 2W*

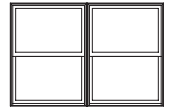

ITDH4256 2W*

5-0 (1524)
5-0 1/4 (1530)
4-11 3/4 (1518)



ITDH2260 2W

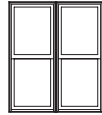

ITDH2660 2W

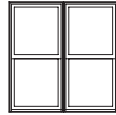

ITDH3060 2W

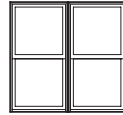

ITDH3260 2W

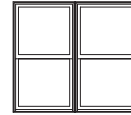

ITDH3460 2W

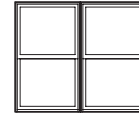

ITDH3660 2W*

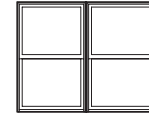

ITDH3860 2W*

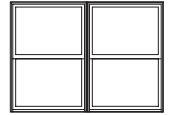

ITDH4260 2W*

5-4 (1626)
5-4 1/4 (1632)
5-3 3/4 (1619)



ITDH2264 2W

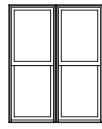

ITDH2664 2W

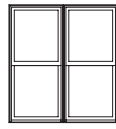

ITDH3064 2W

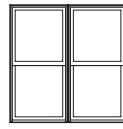

ITDH3264 2W*

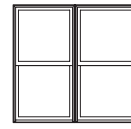

ITDH3464 2W*

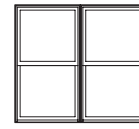

ITDH3664 2W*

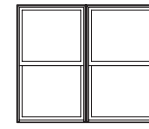

ITDH3864 2W*

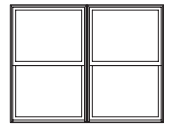

ITDH4264 2W*

5-8 (1727)
5-8 1/4 (1734)
5-7 3/4 (1721)



ITDH2268 2W



ITDH2668 2W

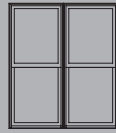

ITDH3068 2W

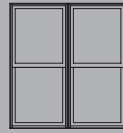

ITDH3268 2W*

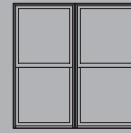

ITDH3468 2W

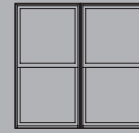

ITDH3668 2W

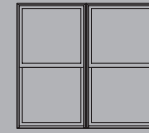

ITDH3868 2W*

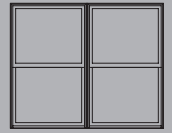

ITDH4268 2W*

6-0 (1829)
6-0 1/4 (1835)
5-11 3/4 (1822)



ITDH2272 2W

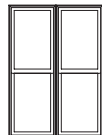

ITDH2672 2W

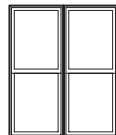

ITDH3072 2W*

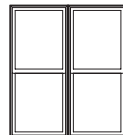

ITDH3272 2W*

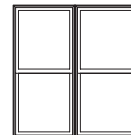

ITDH3472 2W*

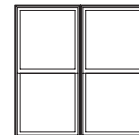

ITDH3672 2W*

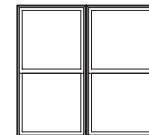

ITDH3872 2W*



ITDH4272 2W*

6-4 (1930)
6-4 1/4 (1937)
6-3 3/4 (1924)

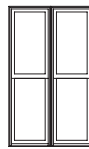

ITDH2276 2W

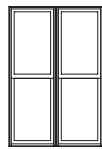

ITDH2676 2W



ITDH3076 2W*

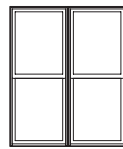

ITDH3276 2W*

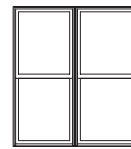

ITDH3476 2W*

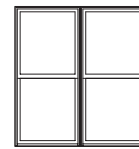

ITDH3676 2W*

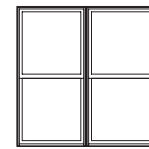

ITDH3876 2W*

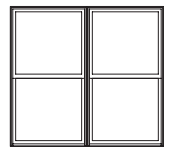

ITDH4276 2W*

DOUBLE HUNG

3 Wide Operator Units - 22", 26", 30", 32" Widths

Mas. Opp. (mm)	5-5 (1651)	6-5 (1956)	7-5 (2261)	7-11 (2413)
Rgh. Opp. (mm)	5-5 1/2 (1664)	6-5 1/2 (1969)	7-5 1/2 (2273)	7-11 1/2 (2426)
Frame Size (mm)	5-4 1/2 (1638)	6-4 1/2 (1943)	7-4 1/2 (2248)	7-10 1/2 (2400)

3-0 (914) 3-0 1/4 (921) 2-11 3/4 (908)				
3-4 (1016) 3-4 1/4 (1022) 3-3 3/4 (1010)				
3-8 (1176) 3-8 1/4 (1124) 3-7 3/4 (1111)				
4-0 (1219) 4-0 1/4 (1226) 3-11 3/4 (1213)				
4-4 (1321) 4-4 1/4 (1327) 4-3 3/4 (1314)				
4-8 (1422) 4-8 1/4 (1429) 4-7 3/4 (1416)				
5-0 (1524) 5-0 1/4 (1530) 4-11 3/4 (1518)				
5-4 (1626) 5-4 1/4 (1632) 5-3 3/4 (1619)				
5-8 (1727) 5-8 1/4 (1734) 5-7 3/4 (1721)				
6-0 (1829) 6-0 1/4 (1835) 5-11 3/4 (1822)				
6-4 (1930) 6-4 1/4 (1937) 6-3 3/4 (1924)				

Details and Elevations not to scale.

When ordering 6 3/16" (167 mm) jambs, add 1/4" (6 mm) to width and 1/8" (3 mm) to height for Rough Opening, Frame Size and Masonry Opening.

■ = Available in Cottage Style with unequal sash. Cottage Style Glass size (min) 36 3/4" (933) / 24 3/4" (629).

MULTIPLE ASSEMBLIES

Multiple assemblies can be factory mullied up to 4 units wide by 1 unit high,

MAXIMUM ROUGH OPENING
not to exceed 113 1/2" x 76 1/4"; OR
up to 2 units wide by 2 units high.

MAXIMUM ROUGH OPENING:
not to exceed 84" x 96". Field mull kits are available. Structural mullion reinforcement is required for some assemblies. Please consult your local Integrity from Marvin representative for more information.

Construction Details

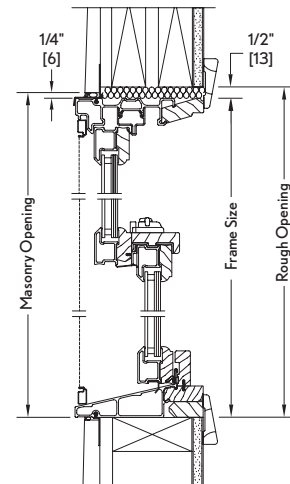

Operator Head Jamb and Sill

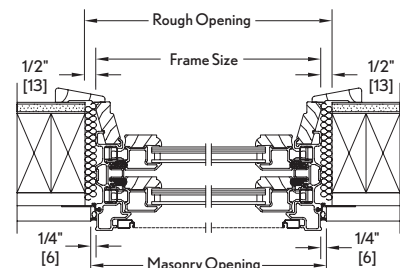

Operator Jamb

DOUBLE HUNG

INTEGRITY® FROM MARVIN®
WOOD-ULTREX® SERIES

3 Wide Operator Units - 34", 36", 38" Widths

Mas. Opg. (mm)	8-5 (2565)	8-11 (2718)	9-5 (2870)
Rgh. Opg. (mm)	8-5 1/2 (2578)	8-11 1/2 (2731)	9-5 1/2 (2883)
Frame Size (mm)	8-4 1/2 (2553)	8-10 1/2 (2705)	9-4 1/2 (2858)

Details and Elevations not to scale.

When ordering 6 9/16" (167 mm) or 6 13/16" (173 mm) jambs, add 1/4" (6 mm) to width and 1/8" (3 mm) to height for Rough Opening, Frame Size and Masonry Opening.

















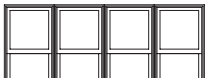

■ = Available in Cottage Style with unequal sash. Cottage Style Glass size (min) 36 3/4" (933) / 24 3/4" (629).

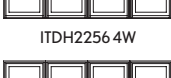
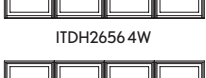
3-0 (914) 3-0 1/4 (921) 2-11 3/4 (908)			
ITDH3436 3W	ITDH3636 3W	ITDH3836 3W	
3-4 (1016) 3-4 1/4 (1022) 3-3 3/4 (1010)			
ITDH3440 3W	ITDH3640 3W	ITDH3840 3W	
3-8 (1176) 3-8 1/4 (1124) 3-7 3/4 (1111)			
ITDH3444 3W	ITDH3644 3W	ITDH3844 3W	
4-0 (1219) 4-0 1/4 (1226) 3-11 3/4 (1213)			
ITDH3448 3W	ITDH3648 3W	ITDH3848 3W	
4-4 (1321) 4-4 1/4 (1327) 4-3 3/4 (1314)			
ITDH3452 3W	ITDH3652 3W	ITDH3852 3W	
4-8 (1422) 4-8 1/4 (1429) 4-7 3/4 (1416)			
ITDH3456 3W	ITDH3656 3W	ITDH3856 3W*	
5-0 (1524) 5-0 1/4 (1530) 4-11 3/4 (1518)			
ITDH3460 3W	ITDH3660 3W	ITDH3860 3W	
5-4 (1626) 5-4 1/4 (1632) 5-3 3/4 (1619)			
ITDH3464 3W	ITDH3664 3W	ITDH3864 3W	
5-8 (1727) 5-8 1/4 (1734) 5-7 3/4 (1721)			
ITDH3468 3W	ITDH3668 3W	ITDH3868 3W	
6-0 (1829) 6-0 1/4 (1835) 5-11 3/4 (1822)			
ITDH3472 3W	ITDH3672 3W	ITDH3872 3W	
6-4 (1930) 6-4 1/4 (1937) 6-3 3/4 (1924)			
ITDH3476 3W	ITDH3676 3W	ITDH3876 3W	

DOUBLE HUNG

4 Wide Operator Units - 22", 26" Widths

Mas. Opg. (mm)	7-2 1/2 (2197)	8-6 1/2 (2604)
Rgh. Opg. (mm)	7-3 (2210)	8-7 (2616)
Frame Size (mm)	7-2 (2184)	8-6 (2591)

3-0 (914) 3-0 1/4 (921) 3-0 1/2 (928)		
ITDH2236 4W	ITDH2636 4W	
3-4 (1016) 3-4 1/4 (1022) 3-3 3/4 (1010)		
ITDH2240 4W	ITDH2640 4W	
3-8 (1176) 3-8 1/4 (1124) 3-7 3/4 (1111)		
ITDH2244 4W	ITDH2644 4W	
4-0 (1219) 4-0 1/4 (1226) 3-11 3/4 (1213)		
ITDH2248 4W	ITDH2648 4W	
4-4 (1321) 4-4 1/4 (1327) 4-3 3/4 (1314)		
ITDH2252 4W	ITDH2652 4W	
4-8 (1422) 4-8 1/4 (1429) 4-7 3/4 (1416)		
ITDH2256 4W	ITDH2656 4W	
5-0 (1524) 5-0 1/4 (1530) 4-11 3/4 (1518)		
ITDH2260 4W	ITDH2660 4W	
5-4 (1626) 5-4 1/4 (1632) 5-3 3/4 (1619)		
ITDH2264 4W	ITDH2664 4W	
5-8 (1727) 5-8 1/4 (1734) 5-7 3/4 (1721)		
ITDH2268 4W	ITDH2668 4W	
6-0 (1829) 6-0 1/4 (1835) 5-11 3/4 (1822)		
ITDH2272 4W	ITDH2672 4W	
6-4 (1930) 6-4 1/4 (1937) 6-3 3/4 (1924)		
ITDH2276 4W	ITDH2676 4W	

In-Sash Transoms Mulled Over Double Hungs

Mas. Opg. (mm)	1-10 (559)	2-6 (762)
Rgh. Opg. (mm)	1-10 1/2 (572)	2-6 1/2 (775)
Frame Size (mm)	1-9 1/2 (546)	2-5 1/2 (749)

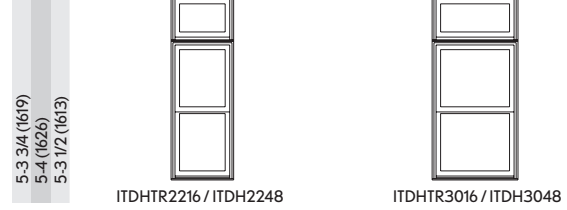

ITDHTR2216 / ITDH2248

ITDHTR3016 / ITDH3048

Details and Elevations not to scale.

When ordering 6 9/16" (167 mm) or 6 13/16" (173 mm) jambs, add 1/4" (6 mm) to width and 1/8" (3 mm) to height for Rough Opening, Frame Size and Masonry Opening.

■ = Available in Cottage Style with unequal sash. Cottage Style Glass size (min) 36 3/4" (933) / 24 3/4" (629).

DOUBLE HUNG PICTURE

INTEGRITY® FROM MARVIN®
WOOD-ULTREX® SERIES

Picture Units

Mas. Opg. (mm)	3-2 (965)	3-6 (1067)	4-2 (1270)	4-6 (1372)	5-2 (1575)
Rgh. Opg. (mm)	3-2 1/2 (978)	3-6 1/2 (1080)	4-2 1/2 (1283)	4-6 1/2 (1384)	5-2 1/2 (1588)
Frame Size (mm)	3-1 1/2 (953)	3-5 1/2 (1054)	4-1 1/2 (1257)	4-5 1/2 (1359)	5-1 1/2 (1562)
Glass Size (mm)	32 3/4" (832)	36 3/4" (933)	44 3/4" (1137)	48 3/4" (1238)	56 3/4" (1441)

3-4 (1016)					
3-4 1/4 (1022)					
3-3 3/4 (1010)					
34 3/4 (883)					
3-8 (1176)					
3-8 1/4 (1124)					
3-7 3/4 (1111)					
38 3/4 (984)					
4-0 (1219)					
4-0 1/4 (1226)					
3-11 3/4 (1213)					
42 3/4 (1086)					
4-4 (1321)					
4-4 1/4 (1327)					
4-3 3/4 (1314)					
46 3/4 (1187)					
4-8 (1422)					
4-8 1/4 (1429)					
4-7 3/4 (1416)					
50 3/4 (1289)					
5-0 (1524)					
5-0 1/4 (1530)					
4-11 3/4 (1518)					
54 3/4 (1391)					
5-4 (1626)					
5-4 1/4 (1632)					
5-3 3/4 (1619)					
58 3/4 (1492)					

Details and Elevations not to scale.

T = Standard Tempered

Optional picture Grilles, GBGs and SDLs are available in a standard Rectangular cut shown. Also available in Prairie lite cuts.

Construction Details

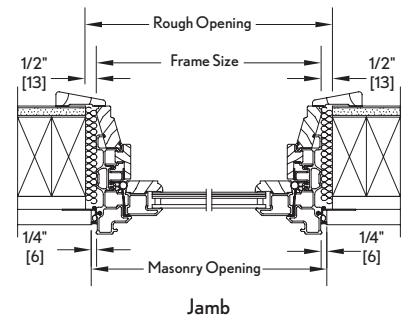
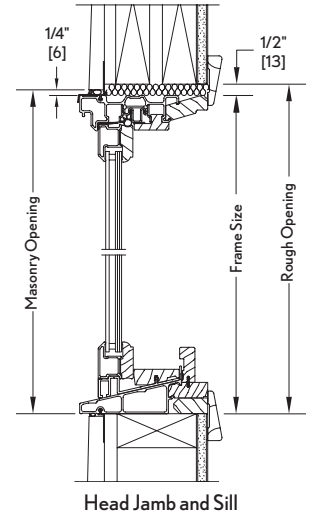

DOUBLE HUNG PICTURE

Picture Units



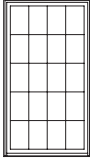
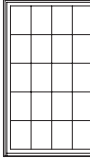
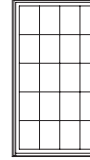
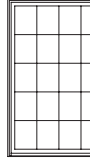
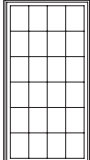
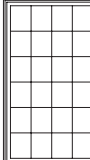
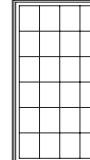
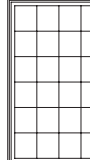
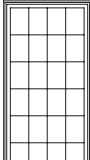
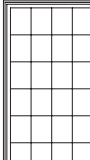
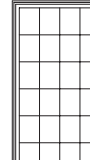
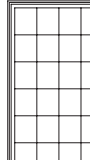





Mas. Opp. (mm)	3-2 (965)	3-6 (1067)	4-2 (1270)	4-6 (1372)
Rgh. Opp. (mm)	3-2 1/2 (978)	3-6 1/2 (1080)	4-2 1/2 (1283)	4-6 1/2 (1384)
Frame Size (mm)	3-1 1/2 (953)	3-5 1/2 (1054)	4-1 1/2 (1257)	4-5 1/2 (1359)
Glass Size (mm)	32 3/4" (832)	36 3/4" (933)	44 3/4" (1137)	48 3/4" (1238)

<p>5-8 (1727) 5-8 1/4 (1734) 5-7 3/4 (1721) 62 3/4" (1594)</p>				
	ITDHP3868	ITDHP4268	ITDHP5068	ITDHP5468
<p>6-0 (1829) 6-0 1/4 (1835) 5-11 3/4 (1822) 66 3/4" (1695)</p>				
	ITDHP3872	ITDHP4272	ITDHP5072	ITDHP5472
<p>6-4 (1930) 6-4 1/4 (1937) 6-3 3/4 (1924) 70 3/4" (1797)</p>				
	ITDHP3876	ITDHP4276	ITDHP5076	ITDHP5476

DOUBLE HUNG Transoms and Multiple Assemblies











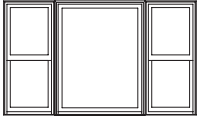
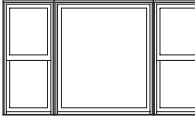
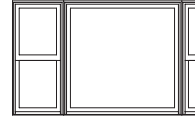
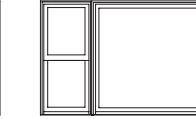



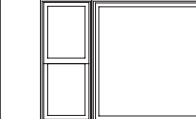

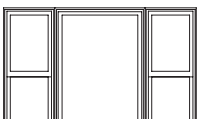
In-Sash Transom and Picture Units

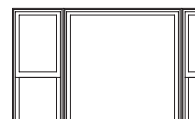
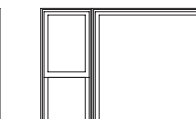
Mas. Opp. (mm)	1-10 (559)	2-2 (660)	2-6 (762)	2-8 (812)	2-10 (864)	3-0 (914)	3-2 (965)	3-6 (1067)
Rgh. Opp. (mm)	1-10 1/2 (572)	2-2 1/2 (673)	2-6 1/2 (775)	2-8 1/2 (825)	2-10 1/2 (876)	3-0 1/2 (927)	3-2 1/2 (978)	3-6 1/2 (1080)
Frame Size (mm)	1-9 1/2 (546)	2-1 1/2 (648)	2-5 1/2 (749)	2-7 1/2 (800)	2-9 1/2 (851)	2-11 1/2 (902)	3-1 1/2 (953)	3-5 1/2 (1054)
Glass Size (mm)	16 3/4" (425)	20 3/4" (527)	24 3/4" (629)	2-6 3/4" (679)	28 3/4" (730)	30 3/4" (781)	32 3/4" (832)	36 3/4" (933)

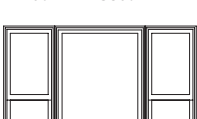
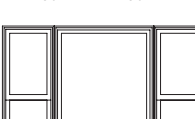
<p>1-4 (406) 1-4 1/4 (413) 1-3 3/4 (400) 10 3/4" (273)</p>								
	ITDHTR2216T	ITDHTR2616T	ITDHTR3016T	ITDHTR3216	ITDHTR3416T	ITDHTR3616T	ITDHTR3816T	ITDHTR4216T

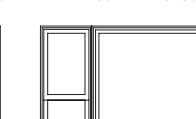

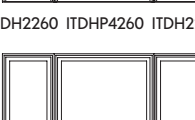
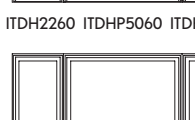
22" Flankers with Picture Center Unit (Assemblies also available with 26 flankers.)

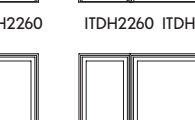
Mas. Opg. (mm)	6-9 (2057)	7-1 (2159)	7-9 (2362)	8-1 (2464)	8-9 (2667)
Rgh. Opg. (mm)	6-9 1/2 (2070)	7-1 1/2 (2172)	7-9 1/2 (2375)	8-1 1/2 (2477)	8-9 1/2 (2680)
Frame Size (mm)	6-8 1/2 (2045)	7-0 1/2 (2146)	7-8 1/2 (2350)	8-0 1/2 (2451)	8-8 1/2 (2654)

4-0 (1219) 4-0 1/4 (1226) 3-11 3/4 (1213)					
	ITDH2248 ITDHP3848 ITDH2248	ITDH2248 ITDHP4248 ITDH2248	ITDH2248 ITDHP5048 ITDH2248	ITDH2248 ITDHP5448 ITDH2248	ITDH2248 ITDHP6248 ITDH2248
4-4 (1321) 4-4 1/4 (1327) 4-3 3/4 (1314)					
	ITDH2252 ITDHP3852 ITDH2252	ITDH2252 ITDHP4252 ITDH2252	ITDH2252 ITDHP5052 ITDH2252	ITDH2252 ITDHP5452 ITDH2252	ITDH2252 ITDHP6252 ITDH2252
4-8 (1422) 4-8 1/4 (1429) 4-7 3/4 (1416)					
	ITDH2256 ITDHP3856 ITDH2256	ITDH2256 ITDHP4256 ITDH2256	ITDH2256 ITDHP5056 ITDH2256	ITDH2256 ITDHP5456 ITDH2256	ITDH2256 ITDHP6256 ITDH2256
5-0 (1524) 5-0 1/4 (1530) 4-11 3/4 (1518)					
	ITDH2260 ITDHP3860 ITDH2260	ITDH2260 ITDHP4260 ITDH2260	ITDH2260 ITDHP5060 ITDH2260	ITDH2260 ITDHP5460 ITDH2260	ITDH2260 ITDHP6260 ITDH2260
5-4 (1626) 5-4 1/4 (1632) 5-3 3/4 (1619)					
	ITDH2264 ITDHP3864 ITDH2264	ITDH2264 ITDHP4264 ITDH2264	ITDH2264 ITDHP5064 ITDH2264	ITDH2264 ITDHP5464 ITDH2264	ITDH2264 ITDHP6264 ITDH2264

Cottage Style Flankers with Picture Center Unit

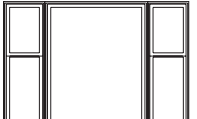
Mas. Opg. (mm)	8-1 (2464)	8-9 (2667)	9-5 (2870)
Rgh. Opg. (mm)	8-1 1/2 (2477)	8-9 1/2 (2680)	9-5 1/2 (2883)
Frame Size (mm)	8-0 1/2 (2451)	8-8 1/2 (2654)	9-4 1/2 (2858)

5-8 (1727) 5-8 1/4 (1734) 5-7 3/4 (1721)			
	ITDH2268 ITDHP5468 ITDH2268	ITDH2668 ITDHP5468 ITDH2668	ITDH3068 ITDHP5468 ITDH3068

Details and Elevations not to scale.

When ordering 6 9/16" (167 mm) or 6 13/16" (173 mm) jambs, add 1/4" (6 mm) to width and 1/8" (3 mm) to height for Rough Opening, Frame Size and Masonry Opening.

Optional transom Grilles, GBGs and SDLs are available in a standard Rectangular cut. Alternate transom lite cuts available to align with select lite cut options.