

INSWING FRENCH DOOR

Inswing French Doors

Mas. Opp. (mm)	2-6 13/16 (783)	2-8 13/16 (834)	3-0 13/16 (935)
Rgh. Opp. (mm)	2-7 5/16 (796)	2-9 5/16 (846)	3-1 5/16 (948)
Frame Size (mm)	2-6 5/16 (770)	2-8 5/16 (821)	3-0 5/16 (923)
Glass Size (mm)	22 19/32" (574)	24 19/32" (625)	28 19/32" (726)

6-7 3/4 (2026) 6-8 (2032) 6-7 1/2 (2019) 6-8 9/32" (1734)									
IIFD2665 O	IIFD2665 XR	IIFD2665 XL	IIFD2865 O	IIFD2865 XR	IIFD2865 XL	IIFD3065 O	IIFD3065 XR	IIFD3065 XL	
6-10 1/4 (2089) 6-10 1/2 (2096) 6-10 (2083) 7-0 25/32" (1798)									
IIFD2668 O	IIFD2668 XR	IIFD2668 XL	IIFD2868 O	IIFD2868 XR	IIFD2868 XL	IIFD3068 XO	IIFD3068 XR	IIFD3068 XL	
7-11 3/4 (2432) 8-0 (2438) 7-11 1/2 (2426) 8-4 9/32" (2141)									
IIFD2680 O	IIFD2680 XR	IIFD2680 XL	IIFD2880 O	IIFD2880 XR	IIFD2880 XL	IIFD3080 O	IIFD3080 XR	IIFD3080 XL	

Inswing Door Operation

X signifies an operating door panel, O means stationary. Listing the panels in a door starts from the left to the right, looking from the exterior.

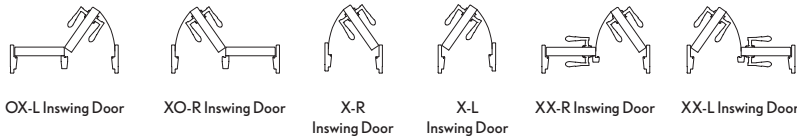

Details and Elevations not to scale.

*2 panel XO also available in OX

**2 and 3 panel XX configurations also available in XX R.

O = Stationary X = Operator
L = Left Hand Panel R = Right Hand Panel

Optional Inswing French Door Grilles, GBGs, SDLs and SDLs with Spacer Bar are available in a standard Rectangular cut shown.

Inswing French Door Direct Glaze Transoms

Mas. Opp. (mm)	3-0 13/16 (935)	5-11 1/2 (1816)	8-11 13/16 (2738)
Rgh. Opp. (mm)	3-1 5/16 (948)	6-0 (1829)	9-0 5/16 (2751)
Frame Size (mm)	3-0 5/16 (923)	5-11 (1803)	8-11 5/16 (2726)
Glass Size (mm)	33 1/2" (851)	68 3/16" (1732)	104 1/2" (2654)

1-4 (406) 1-4 1/4 (413) 1-3 3/4 (400) 12 15/16" (329)			
IIFDG3616	IIFDG7216	IIFDG10816	

Transom units have a 2" jamb extension for 6 9/16" jambs or a 2 1/4" jamb extension for 6 13/16" jambs. When ordering 6 9/16" or 6 13/16" jambs, add 1/4" to width and 1/8" to height of Frame Size (FS), Rough Opening (RO), or Masonry Opening (MO).

Optional Direct Glaze transom Grilles, GBGs, SDLs and SDLs with Spacer Bar are available in a standard Rectangular cut, as shown. Alternate transom lite cuts available to align with select lite cut options.

MULTIPLE ASSEMBLIES

Multiple assembly units can be factory mulled up to 3 units wide by 1 unit high, Maximum Rough Opening not to exceed 109 15/16" x 96"; or 2 units wide by 2 units high, maximum Rough Opening not to exceed 73 5/8" x 100 1/2". Field mull kits available for up to 3 units wide by 2 units high not to exceed 110" x 112". True Half Round transoms are available field mulled only. Structural mullion reinforcement is required for some assemblies. Please consult your local Integrity from Marvin representative for more information.

INSWING FRENCH DOOR

INTEGRITY® FROM MARVIN®
WOOD-ULTREX® SERIES

Inswing French Doors

Mas. Opg. (mm)	4-11 1/2 (1511)	5-3 1/2 (1613)	5-11 1/2 (1816)
Rgh. Opg. (mm)	5-0 (1524)	5-4 (1626)	6-0 (1829)
Frame Size (mm)	4-11 (1499)	5-3 (1600)	5-11 (1803)
Glass Size (mm)	22 19/32" (574)	24 19/32" (625)	28 19/32" (726)

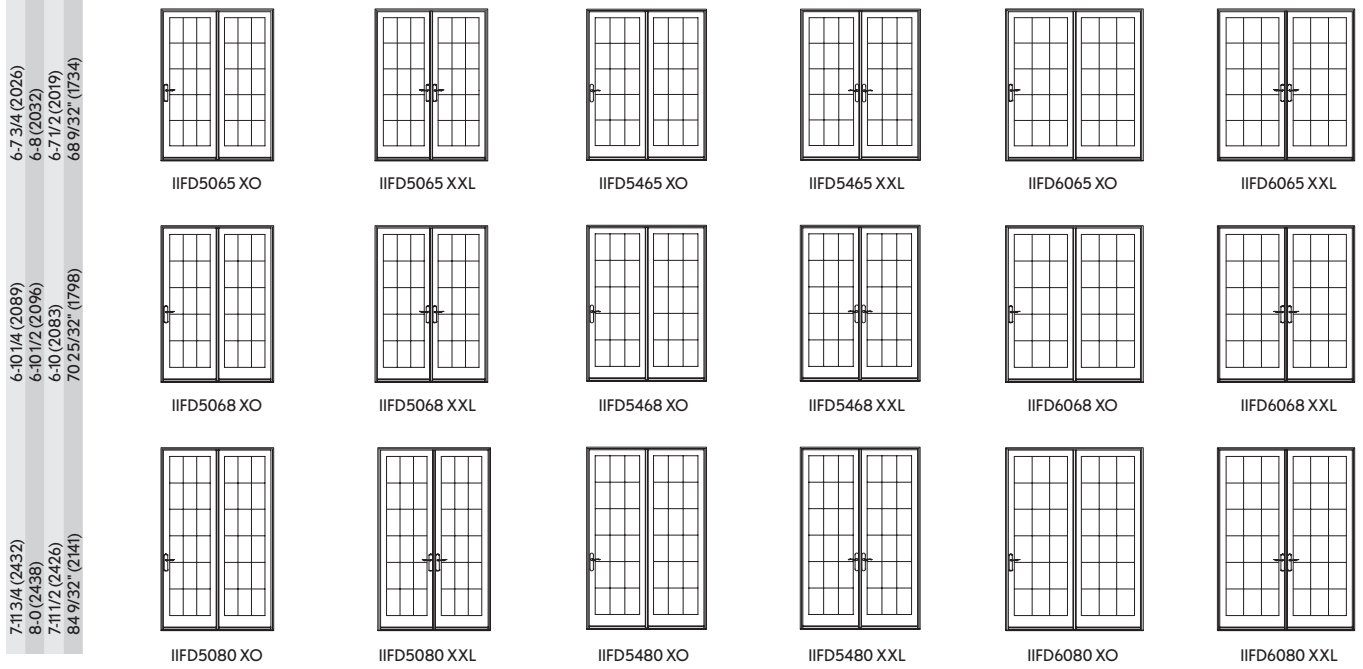

Construction Details

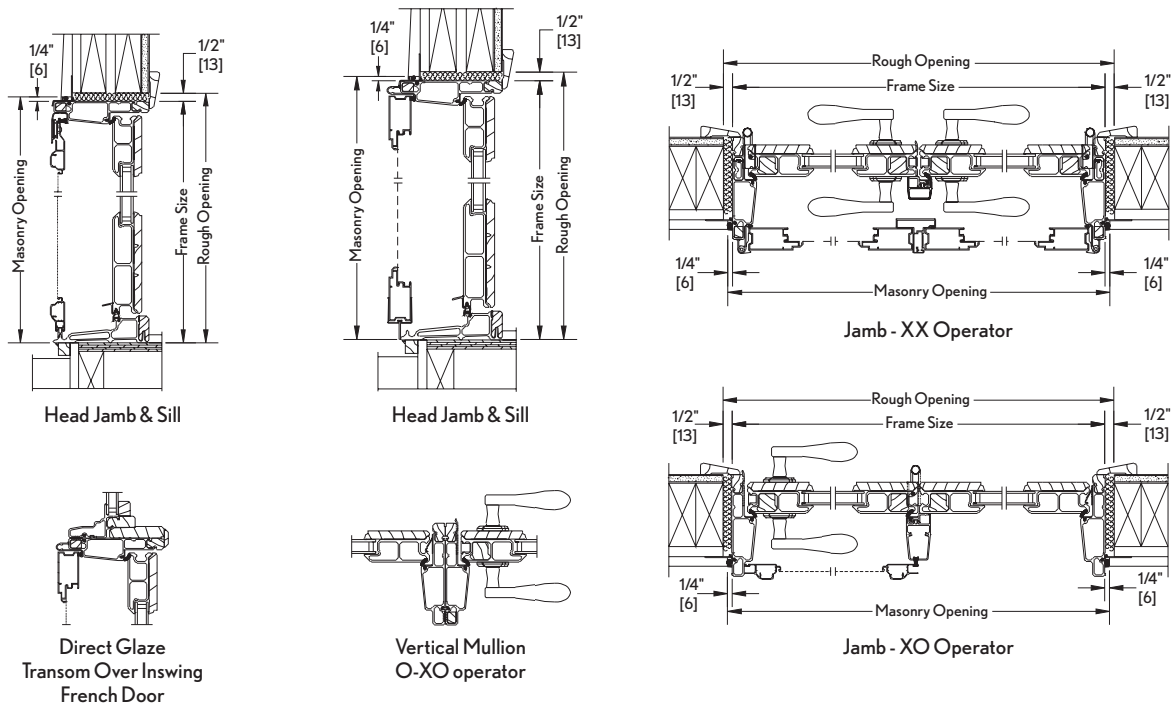

INSWING FRENCH DOOR

Multiple Assemblies - 3 Panel

Mas. Opp. (mm)	7-5 13/16 (2281)	7-5 13/16 (2281)	7-7 7/16 (2323)	7-5 13/16 (2281)
Rgh. Opp. (mm)	7-6 5/16 (2294)	7-6 5/16 (2294)	7-7 15/16 (2335)	7-6 5/16 (2294)
Frame Size (mm)	7-5 5/16 (2269)	7-5 5/16 (2269)	7-6 15/16 (2310)	7-5 5/16 (2269)

6-10 1/4 (2089)
6-10 1/2 (2096)
6-10 (2083)

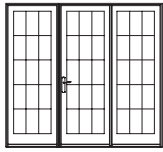

IIFD2668 / IIFD5068 XO

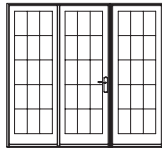

IIFD5068 OX / IIFD2668

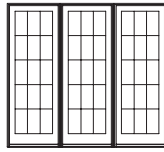

IIFD2668 / IIFD2668 / IIFD2668

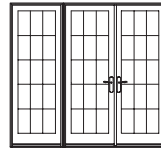

IIFD2668 / IIFD5068 XXL**

Mas. Opp. (mm)	8-11 13/16 (2738)	8-11 13/16 (2738)	9-1 7/16 (2780)	8-11 13/16 (2738)
Rgh. Opp. (mm)	9-0 5/16 (2751)	9-0 5/16 (2751)	9-1 15/16 (2792)	9-0 5/16 (2751)
Frame Size (mm)	8-11 5/16 (2726)	8-11 5/16 (2726)	9-0 15/16 (2767)	8-11 5/16 (2726)

6-10 1/4 (2089)
6-10 1/2 (2096)
6-10 (2083)

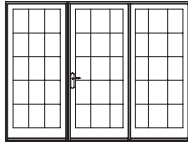

IIFD3068 / IIFD6068 XO

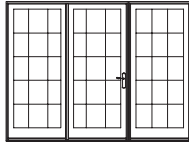

IIFD6068 OX / IIFD3068

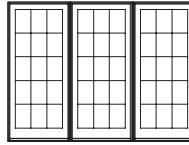

IIFD3068 / IIFD3068 / IIFD3068

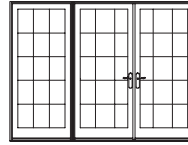

IIFD3068 / IIFD6068 XXL**

Round Top Over Inswing French Door

Mas. Opp. (mm)	5-11 1/2 (1816)
Rgh. Opp. (mm)	6-0 (1829)
Frame Size (mm)	5-11 (1803)

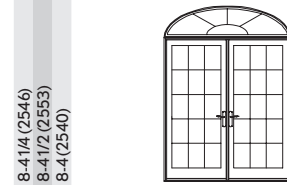

IRTDR7218 / IIFD6068 XXL

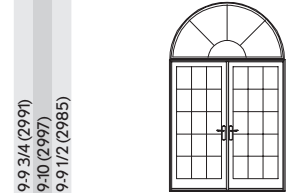

IRTDR7236* / IIFD6068 XXL

8-4 1/4 (2546)
8-4 1/2 (2553)
8-4 (2540)

9-9 3/4 (2991)
9-10 (2997)
9-9 1/2 (2985)

Direct Glaze Transom Over Inswing French Door

Mas. Opp. (mm)	3-0 13/16 (935)	3-0 13/16 (935)	5-11 1/2 (1816)
Rgh. Opp. (mm)	3-1 5/16 (948)	3-1 5/16 (948)	6-0 (1829)
Frame Size (mm)	3-0 5/16 (923)	3-0 5/16 (923)	5-11 (1803)

8-2 (2489)
8-2 1/4 (2496)
8-1 3/4 (2483)



IIFDG3616 / IIFD3068 XR

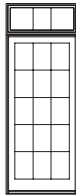

IIFDG3616 / IIFD3068 O

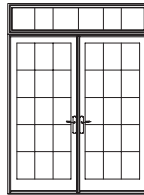

IIFDG7216 / IIFD6068 XXL

Details and Elevations not to scale.

*This product is only available field mullled.

**2 and 3 panel XX configurations also available in XX R.

O = Stationary X = Operator

Optional Round Top SDL/Grilles and SDL with Spacer Bar are available in a standard cut, as shown. (Round Top divided lites only available in standard lite cut.)

MULTIPLE ASSEMBLIES

Multiple assembly units can be factory mullled up to 3 units wide by 1 unit high, Maximum Rough Opening not to exceed 109 15/16" x 96"; or 2 units wide by 2 units high, maximum Rough Opening not to exceed 73 5/8" x 100 1/2". Field mull kits available for up to 3 units wide by 2 units high not to exceed 110" x 112". True Half Round transoms are available field mullled only. Structural mullion reinforcement is required for some assemblies. Please consult your local Integrity from Marvin representative for more information.